

2008 Annual Report

Cecil H. & Ida M. Green Institute of Geophysics & Planetary Physics

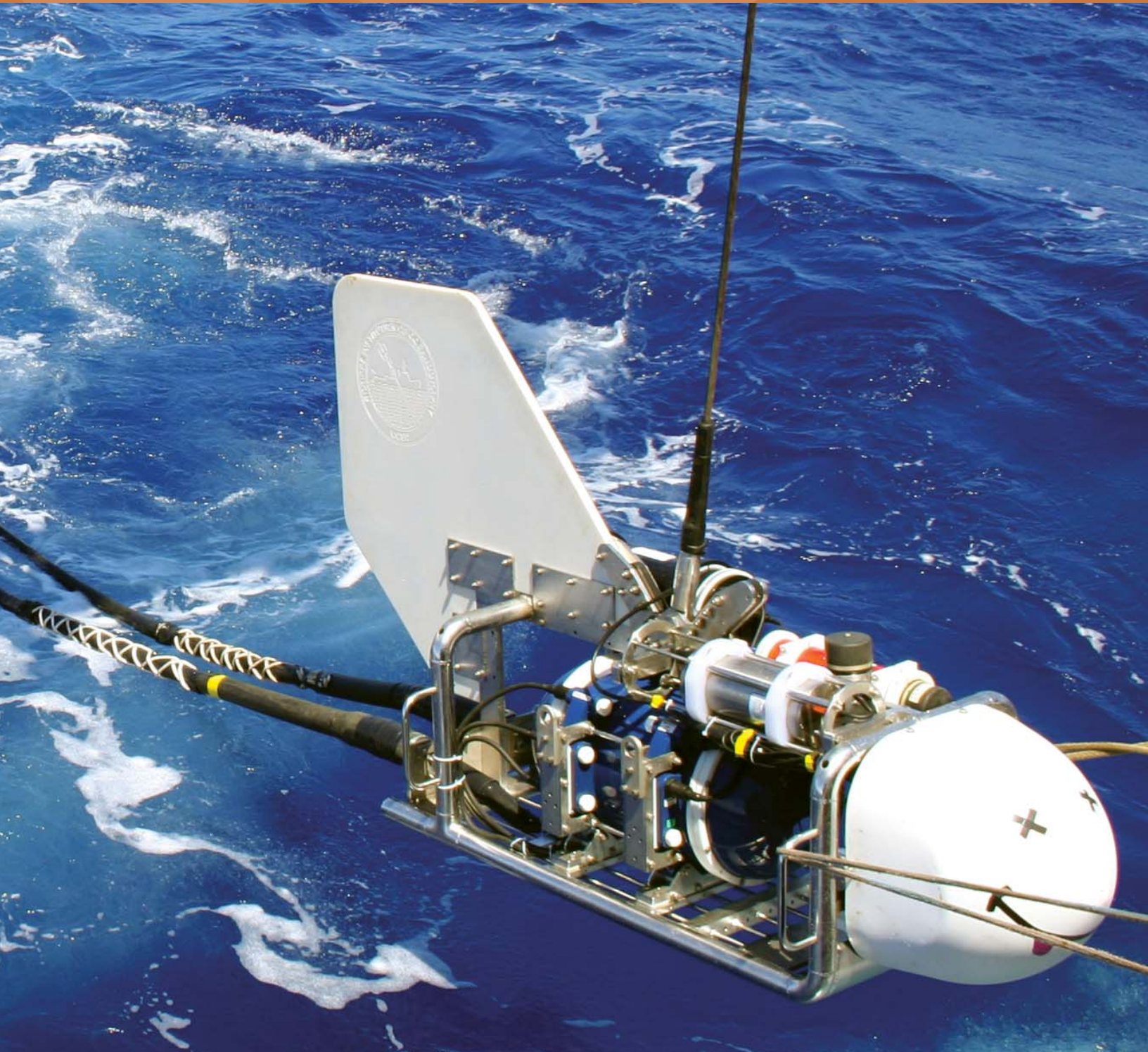

IGPP Annual Report

You see before you the 2008 Annual Report of the Cecil and Ida Green Institute of Geophysics and Planetary Physics. Each year we compile a concise summary of the work of our scientists covering the last academic year. The goal is to give the scientifically literate, but not necessarily expert, reader an overview of the research we at IGPP are engaged in, without indulging in hype or falling into oversimplification. We trust prospective students, scanning the Internet will find this summary helpful, as well as friends of IGPP and academic reviewers.

The range of topics continues to be very wide, spanning physical oceanography, deep-Earth and crustal seismology, paleomagnetism, geomagnetism, and electromagnetic sounding. IGPP has a strong tradition of instrument development: in this issue we report work on improved marine electromagnetic survey instruments, a new fiber-optic borehole strainmeter, and an advanced SPAR buoy to be used as an unmanned deep-ocean observatory. At the abstract end of the spectrum we find a the discovery of a new class of orthogonal polynomials found to be remarkably efficient for optimization problems centered on the Earth's dynamo.

I believe there is something here of interest for every taste in the Earth sciences.

Robert L. Parker

Deputy Director, Cecil and Ida Green Institute of Geophysics and Planetary Physics

*Image: Screen shot of a fledermaus scene file that allows users to fly around the topography of a drained Lake Tahoe and view seismic sections geo-referenced within the object.
Researcher: Graham Kent*

ACOUSTIC THERMOMETRY, Dzieciuch, Worcester

ACOUSTICS, Blackman, Dzieciuch, Hedlin

ANTARCTIC ICE SHEETS, Fricker

COMPLEXITY, Werner

CRUSTAL DEFORMATION, Agnew, Fialko, Sandwell

CRUSTAL SEISMOLOGY, Kilb, Shearer, Vernon

CYBERINFRASTRUCTURE, Constable, C., Orcutt, Staudigel

EARTH'S DEEP INTERIOR, Constable, S., Parker

EARTHQUAKE MECHANISMS, de Groot-Hedlin, Fialko, Kilb,
Shearer, Vernon

ELECTRICAL PROPERTIES, Constable, S.

ELECTROMAGNETIC INDUCTION, Constable, C., Constable S., Parker

FIBEROPTICS, Zumberge

FLUID MECHANICS, Ierley

GODESY, Agnew, Fang, Fialko, Sasagawa

GEODYNAMICS, Laske, Sandwell

GEOMAGNETISM, Ierley, Constable, C.

GEOLOGICAL INSTRUMENTATION, Agnew, Constable, S., Davis,
Sasagawa, Vernon, Zumberge

GLOBAL SEISMOLOGY, Davis, Laske, Shearer

GPS, Agnew, Fang, Fialko

OBSERVATIONAL NETWORKS, Davis, Orcutt, Vernon

OCEAN ACOUSTICS, de Groot-Hedlin, Dzieciuch, Worcester

OCEAN BATHYMETRY, Parker, Sandwell

INFRASOUND, de Groot-Hedlin, Hedlin

INVERSE THEORY, Parker

LANDSCAPE SYSTEMS, Werner

LIDAR, Kent

LUNAR MAGNETISM AND SEISMOLOGY, Johnson

MARINE ELECTROMAGNETIC INDUCTION, Constable, S.

MARINE GEOLOGY, Babcock, Blackman, Harding, Laske, Staudigel

MARINE GRAVITY, Sasagawa, Zumberge

MARINE SEISMOLOGY, Babcock, Harding, Laske, Orcutt

MID-OCEAN RIDGES, Constable, S., Blackman, Harding

MINERAL PHYSICS, Akber

NORMAL MODES, Davis, Laske

NUMERICAL METHODS, Constable, S., Dzieciuch, de Groot-Hedlin

PALEOMAGNETISM, Constable, C.

PALEOSEISMOLOGY, Babcock, Kent

RADAR TECHNIQUES, Fialko, Fricker, Sandwell

REFLECTION SEISMOLOGY, Babcock, Harding, Kent

SATELLITE LASER ALTIMETRY, Fricker

SEAFLOOR GRAVITY, Sasagawa

SEAMOUNTS, Staudigel

SEISMIC ANISOTROPY, Blackman

SEISMIC HAZARDS, Kent

SEISMIC NETWORKS, Davis, Vernon

SEISMOMETERS, Zumberge

SPECTRAL ANALYSIS, Dzieciuch, Parker, Shearer, Vernon

STRAINMETERS, Agnew, Zumberge

TIDES, Davis, Agnew, Wyatt

TURBULENCE, Ierley

VOLCANOS, Hedlin, Staudigel

Duncan Carr Agnew
Professor of Geophysics
Email: dagnew@ucsd.edu
Phone: x42590

Frank K. Wyatt
Principal Development Engineer
Email: fwyatt@ucsd.edu
Phone: x42411

Research Interests: Crustal deformation measurement and interpretation, Earth tides, Southern California earthquakes.

Crustal Deformation (Strainmeters)

As was true last year, a major activity this year has been constructing and operating long-base laser strainmeters as part of the Plate Boundary Observatory, an activity led by Wyatt, supported by staff members Don Elliott and Stephen Dockter. This year, the construction activity has been just south of Cholame, in central California, where we have built two instruments at a location where deep tremor has been detected. These instruments began producing data in late August of 2008, so we can now say that we have met the PBO construction goals on time and within budget. We have also continued to operate the PBO instruments at Salton City (SCS), the PBO and USGS instruments at Durmid Hill (DHL), and the strainmeters at Piñon Flat Observatory (PFO), and Glendale (GVS).

One particularly interesting result for the last year came from the instruments at Durmid Hill, which recorded a long sequence of aseismic strain events at the southern end of the southern San Andreas fault beginning in April 2008. The Coachella segment of the San Andreas, on which these events happened, has an 8-m slip deficit, and its southernmost end, where these strain changes are seen, is a possible initiation point for a future great earthquake.

Figure 1 shows the last 2.4 years of data from some of these sensors (to the end of May 2008). The top panel shows the long-term records from the two laser strainmeters. The long-term rate on the NS instrument is $-0.31 \mu\epsilon/\text{yr}$; the newer EW system shows a rate of $0.49 \mu\epsilon/\text{yr}$ (both instruments are actually 5° counterclockwise to the directions given, to be at 45° to the local fault strike). These rates are consistent with the shear expected from a dislocation model, though their combination implies local dilatation that is not so easily explained. The second panel shows data from the University of Colorado creepmeters (operated by Dr. Roger Bilham) that are located across the fault about 2 and 9 km NW of its closest approach to the strainmeters. Both creepmeters show ongoing cross-fault slip at rates of 1-2 mm/yr, with some left-lateral motion at times of heavy rains. Both creepmeters also show an abrupt signal beginning on 2008:104, which was also very clear on the strainmeters. The third and fourth panels from the top of **Figure 1** show nearby GPS baseline changes, one between DHLG (the GPS station at DHL) and station P505, which is on the other side of the San Andreas. P505 moves only 6 mm/yr in a North-America reference frame; relative to it, DHLG moves 8.2 mm/yr fault-parallel and -0.8 mm/yr fault-normal, with no obvious fluctuations. The other GPS line shown is from P505 to P504; this line is entirely on the east side of the San Andreas, and shows a possible transient beginning sometime in the summer of 2007, though this is combined with a possible annual cycle.

On another creeping section of the San Andreas fault between Parkfield and Hollister, it has been known for some time that creep at the surface often occurs in “events” with relatively rapid slip. The recent changes seen at DHL also seem to occur mostly as events, which the strainmeter data allow us to resolve in great detail, both in strain (1% or better of the total) and in time (1 Hz sampling). The individual events are not simple or repeatable; instead they show a range of waveforms. This is actually useful, since this variety allows us to explore the spatial and temporal behavior of creep events on the fault. In particular, the ratio of strain change on two instruments from one sample to the next restricts, as a function of time, where strain can occur; the challenge is to combine this with other data to produce a plausible history of aseismic slip.

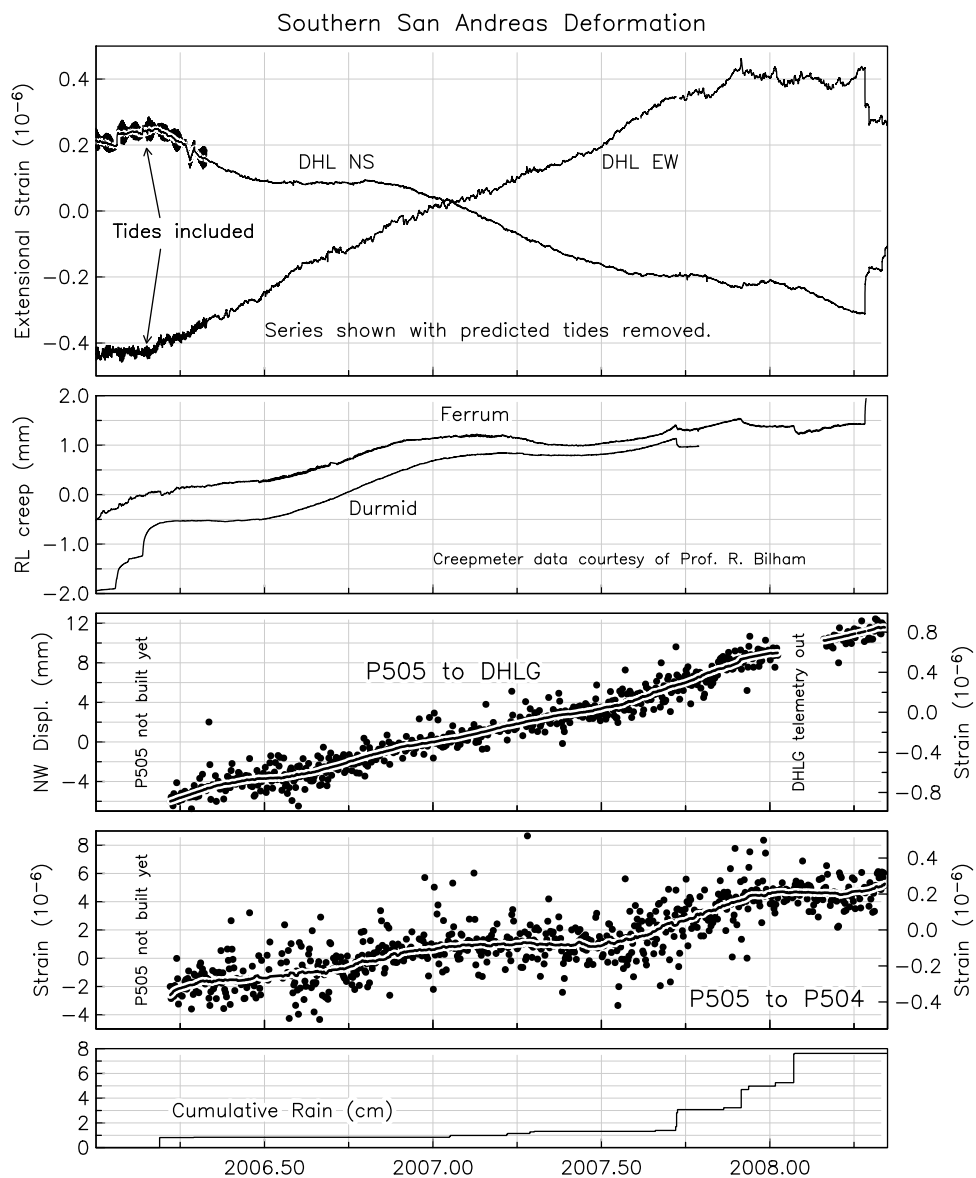

Figure 1

Publications

- Agnew, D. C. (2007) Earth Tides, pp. 163-195, *Treatise on Geophysics: Geodesy*, T. A. Herring, ed., Elsevier, New York.
- Rolandone, F., R. Burgmann, D. C. Agnew, I. A. Johanson, D. C. Templeton, M. A. d'Alessio, S. J. Titus, C. DeMets, and B. Tikoff (2008) Aseismic slip and fault-normal strain along the central creeping section of the San Andreas fault, *Geophys. Res. Lett.* **35**, L14305, doi:10.1029/2008GL034437.
- Agnew, D. C. (2008) Benioff, Victor Hugo, *Complete Dictionary of Scientific Biography* **19** 243-245 (Charles Scribner's Sons); Menard, Henry William, *ibid* **23**, 96-97; Richter, Charles Francis, *ibid* **24** 241-243.

Jonathan Berger
Research Geophysicist
Email: jberger@ucsd.edu
Phone: 42889

Research Interests: Global seismological observations, geophysical instrumentation, deep ocean observing platforms, global communications systems.

For the past several years, I have been working on an advanced SPAR buoy design to be used as an unmanned deep-ocean, moored observatory. The design requirements were based on a multi-year deployment at a mid-Atlantic site for multipurpose measurements (swell, meteorology, aerosols, seismology, ocean basin heat content, and detailed ocean structure). The platform concept, developed first by Technip as an offshore oil production platform, was scaled down for scientific use in partnership with Technip, and Glostex Associates. Called an Extended Draft Platform (EDP), the design will provide substantial power and bandwidth to the seafloor and a stable surface platform for instruments and communications.

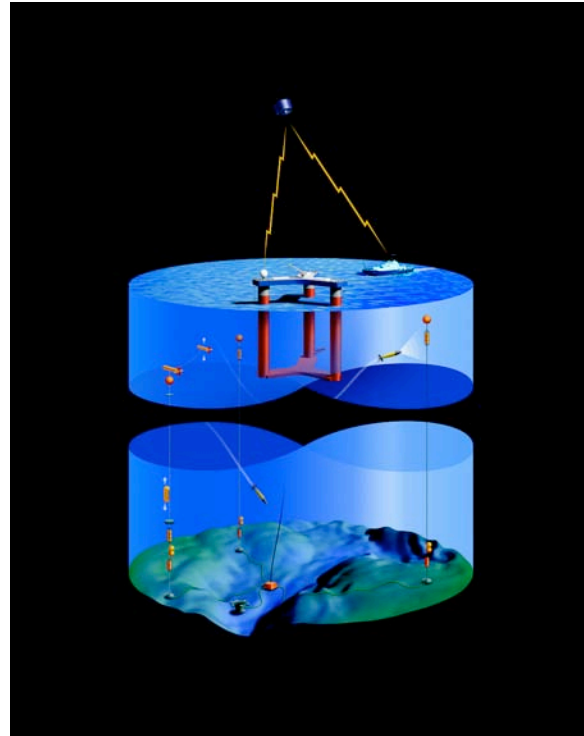

The EDP comprises an upper deck box, three columns and a lower pontoon with the structure behaving like a deep draft semi-submersible or spar buoy. The unique feature of the EDP is that the columns penetrate that deck, and the pontoon can be positioned just below the deck for construction, commissioning, and towing. In this configuration the draft is only about 4m. It will provide a stable platform with large deck space (up to 300 m²) for science experiments and a total payload of over 30 metric tons. Compartments in the three extensions of the deck box are designed to hold all the power, communications and instrumentation equipment. Diesel/solar electric power in the range of 10 kW will be provided for the communications and oceanographic instrumentation systems with tanks to provide one-year between refueling.

The EDP is tri-moored on a combination steel wire/polyester mooring designed to hold the EDP on station while a separate Electro-Optical cable is used for power and data transmission to the seafloor. The seafloor junction box will be supplied with at least 500 W of power. Communications and power delivery between seafloor instruments and the J-Box will be via ROV wet-mateable connectors on the J-Box. Communications between the J-Box and the EDP will be via fiber optic channels. On the EDP, C-band communication channels will be used for telemetry of at least 500 Mbytes/day from the platform to shore. Back-up communications systems will provide independent command and control channels in the event of failure of the principal communications channels.

The expected weather and waves for four global sites for the 50-year extremes are shown in the figure below. (The vertical axis is in m/s, m, or seconds as appropriate.) The platforms should be designed

to operate in the 5-year extremes and survive the 50-year extremes. The wave dominant period of the extreme waves are an essential design specification for both EDP and discus designs.

Using a model of the EDP and the 50-year extremes for the mid-Atlantic site with current, wind and waves aligned between a pair of mooring lines (0°), we find the worst case pitch predicted is $<18^\circ$. The maximum heave is significant - 19.3 ft. However, the 40' clearance between the ocean and platform will prevent wetting the deck with green water even when tilted 18° . In contrast, a discus buoy is a wave follower and hence its heave would be about 56 ft and the pitch equal to the wave slope or nearly 90° . The likelihood of the worst-case scenario in 50 years with current, wind and waves aligned is very small.

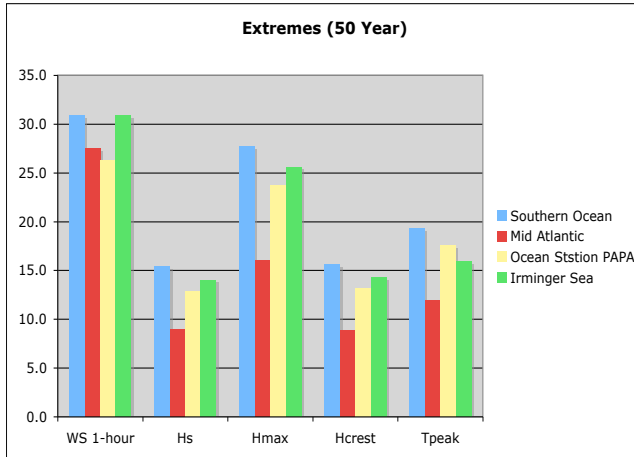

A scale model (1:128) of the platform was constructed and tested in at the Ocean Engineering Center tank in Vancouver, B.C. in to address calm water resistance at both shallow (10.37ft) and deep (75ft) drafts. The shallow draft towing condition was tested both with the stem of the 'Y' forward and using a bridle with the stem of the 'Y' trailing. Towing tests were also conducted in irregular waves in order to gain insight into added resistance and also to observe towing behavior.

Transient oscillation tests were carried out for both the unmoored and moored platform. The model mooring was devised

to approximate the forces and stiffness of the design mooring. Platform motion tests of the moored platform were carried out in a selection of regular waves, moderate irregular seas, and also in a nominal $H_s=5.8\text{m}$, $T_p=11.25\text{s}$ sea representing the upper limit of waves that could confidently be generated in this test basin at the 1:28 scale.

The results from the towing tests were scaled back to the full EDP to determine the expected towing speed. The estimates for towing in calm water and in sea state 4 with 20 kt of ambient wind gave a mean speed-made-good of about 3.5 kt is estimated for the deep tow out condition towed by a 5,000 HP tug. A large UNOLS vessel with 10,000 BHP can tow the system although costs are higher than that for a moderate-sized, ocean-going tug.

In addition to towing tests to calibrate model calculations, tests were conducted with the moored platform with a self-propelled, radio-controlled, tug model intended to represent a resupply/servicing vessel. The types of activities that were simulated were representative of the types of operations necessary for personnel and material transfer when servicing the platform. Most of the tests were performed in either sea state 3 (nominal $H_s = 0.88\text{m}$, $T_p=7.5\text{s}$) or mean sea state 4 (nominal $H_s=1.88\text{m}$, $T_p=8.8\text{s}$). Based on the observations during the tests, sea state 4 represents the limiting condition for transfer of personnel and slung loads utilizing the EDP's supply davit or the ship's crane.

Relevant Publications

Berger, J., J. Orcutt, J. O'Sullivan, and J. Halkyard., The Extended Draft Platform: A deep-ocean science observatory. *Proc. Conf. OCEANS 2008 - MTS/IEEE Quebec City, September 15-18, 2008, ISBN 978-1-4244-2619-5.*

Donna Blackman

Research Geophysicist

Email address: dblackman@ucsd.edu

Phone extension: 48813

Research Interests: tectonic and magmatic processes that occur along plate boundaries with emphasis on oceanic spreading centers; deformation of minerals and the development of seismic anisotropy during mantle flow; hydroacoustic calibration experiments for nuclear test monitoring

Geophysical investigations of oceanic spreading center processes continue to be the main focus of my research. The approaches I use vary both by design and in response to opportunities for seagoing experiments. In 2007/2008 my analyses incorporated data/results from deep sea drilling, shipboard mapping, gravity modeling, and seismic refraction/reflection. Further analysis of prior geophysical from an oceanic core complex on the Mid-Atlantic Ridge provided the basis for more in-depth modeling than had been applied to the area before. Including the effects of 3-D structure within the core complex, a revised gravity model that is consistent with drilling results was obtained. Similarly, the ground truth provided by the recovered drill core were used to guide new tomographic inversions of seismic velocity in the upper ~km of the domal core, which has been exposed by a detachment fault. Working with Graham Kent and Alistair Harding, a downward continuation method was tested on multi-channel seismic data. We confirmed that additional insight into structure in the shallowest part of the section could be obtained with the method and this influences details of the deeper structure required to explain the full data set.

Modeling of mantle flow, led by postdoc Nick Harmon, addresses how variation in the distance between the Tonga trench and the Lau basin backarc spreading centers can influence patterns of melting in the mantle wedge above the subducting plate. Effects of water on the melt production have been explored as have a number of other physical parameters that we aim to relate to geochemical and petrological observations made by colleagues working at the Ridge 2000 Integrated Studies Site on the Eastern Lau Spreading Center.

In my third year as chair of the NSF Ridge 2000 program (<http://www.ridge2000.org>), I worked with colleagues and members of the R2K Office at SIO to facilitate interdisciplinary research on oceanic spreading centers. This research involves biologists, chemists, geophysicists, geologists, and oceanographers, all working to understand the interplay between processes that control rifting and hydrothermal venting along spreading centers. A major effort this year was to document the Program's progress to date (2001-2007) so that a review panel could assess results and decide if the R2K should continue for a full term. The Program was renewed and will continue funding research through 2012, so the normal rotation of the R2K Office to a new host institution and Chair will occur in November this year.

Catherine de Groot-Hedlin to the lead on our hydroacoustic work this year, modeling sound propagation and losses along the source-receiver paths from our 2006/7 experiment across the Antarctic Circumpolar current boundary. Our paper on this work is under review this summer.

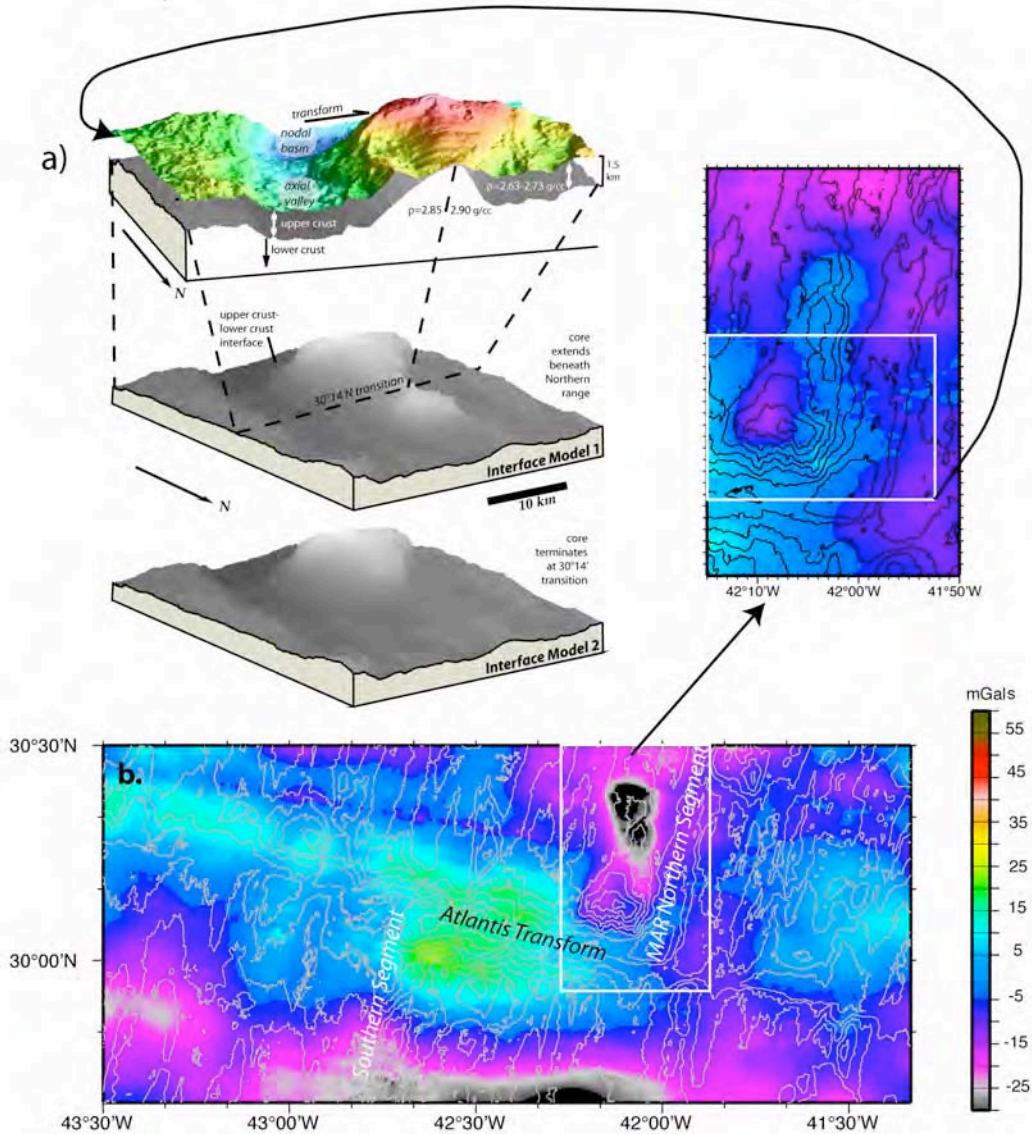

Lower panel of figure shows Mantle Bouguer gravity anomaly map where Mid-Atlantic Ridge segments are offset by Atlantis transform fault. Grey contours show bathymetry at 500 m intervals. Atlantis Massif oceanic core complex on the west flanks of the eastern ridge-transform intersection is shown in the upper panels. At left are bathymetry (color) and models of interface geometry where density contrast between upper (basalt) and lower (gabbroic) crust is assumed. Model 1 results in removal of too much mass (the black anomaly on the west flank in the lower panel) whereas Model 2 can explain much of the Mantle Bouguer (upper right panel; color scale same as in b).

Castelnaud, O., D.K. Blackman, R.A. Lebensohn, and P. Ponte, "Micromechanical modelling of the viscoplastic behavior of Olivine", *J. Geophys. Res.*, 2008 in press.

Blackman, D.K., G.D. Karner, and R.C. Searle, "Three-dimensional structure of oceanic core complexes: effects on gravity signature and ridge flank morphology, Mid-Atlantic Ridge 30° N", *G³*, 9, doi:10.1029/2008GC001951, 2008.

Yehuda Bock

Research Geodesist and Senior Lecturer

Email address: ybock@ucsd.edu

Phone extension: 45292

Research Interests: space geodesy, crustal deformation, natural hazards, GPS seismology, GPS meteorology, GIS and Information Technology

Yehuda Bock's research focuses on space geodetic innovations, which he applies to a wide range of geophysical studies. He has developed new methods for analyzing GPS data ("instantaneous positioning") that can be used for precise real-time monitoring of displacements at high rates (1-50 Hz), in combination with traditional seismic instruments. In *Mattia et al.* [2008] we used instantaneous positioning of 15 s GPS data to define the dimensions and the characteristics of the shallow plumbing system of the 2005-2006 eruption of the Mt. Augustine (Alaska) stratovolcano as a massive migration of magmatic fluids from depth under the effect of gas overpressure. Volcanic eruptions are usually preceded by measurable signals of growing unrest such as increase in seismicity and ground deformation. With Yehuda's real-time methods it is possible to identify precursors of a possible renewal of the volcanic activity and to distinguish between an eruptive activity characterized by an intrusion and a migration of magma stored in the main conduits.

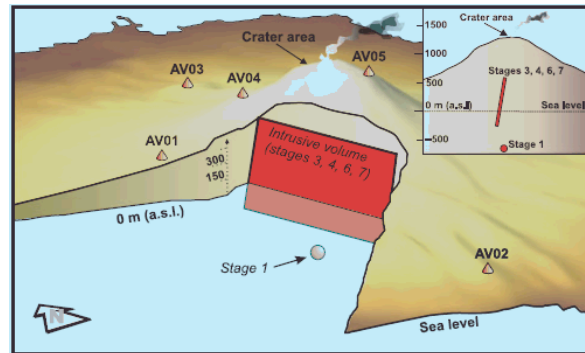

In *Bassis et al.* [2007], we used 2 Hz-sampled GPS data to monitor the tip of a propagating rift on the Amery Ice Shelf over 3 consecutive annual field seasons. Instantaneous positioning allowed us to monitor a network of receivers that were all subject to motion (i.e., there was no stable reference available). This study confirmed that rift propagation is episodic, allowed us to compare icequakes with earthquakes, and provided a first step in understanding the details of meso-scale physics that controls rift propagation over moderate spatio-temporal scales.

In *Kogan et al.* [2008] we monitored the structural response of the Verrazano-Narrows Bridge to 2004 New York City Marathon runners using a Kalman filter analysis of data collected by 5Hz GPS receivers and 100Hz force-balance accelerometers (FBA). The vibrations excited by runners are small in terms of displacements, yet large in terms of accelerations (favoring FBA). On the other hand, the slow deflection under a load of runners is large in terms of displacements while the corresponding accelerations are very small (favoring GPS). The optimal sensitivity is obtained by fusing both data sets, which Yehuda and graduate student Brendan Crowell are applying to earthquake early warning systems.

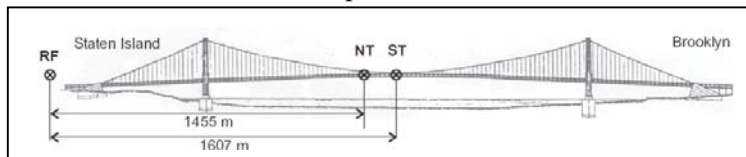

In *Luttrell et al.* [2007] we used instantaneous positioning to rapidly and efficiently measure the current elevation of observed ancient shoreline features to constrain the model parameters of plate thickness and relaxation time in order to estimate the vertical rebound of the Lake Cahuilla area since the last lake fall. The lake cycle causes significant Coulomb stress perturbations on the southern San Andreas fault, comparable to stress magnitudes known to have triggered events on other regional faults. This is important for assessing seismic hazard on the southern San Andreas and San Jacinto faults, which have not had a major rupture in the last 300 years.

Yehuda also directs the Scripps Orbit and Permanent Array Center (<http://sopac.ucsd.edu>), with a staff of 4 programmers who are engaged in several multi-year IT projects for NASA and NOAA. As an example, we have developed the Pocket GPS Manager (PGM) software (see figure below) - a wireless PDA application designed to eliminate the use of paper GPS field logs via direct communication with a set of centralized information services, for planning, collecting, analyzing, interpreting, and publishing GPS-based projects. It has been used in a number of CSRC projects (<http://csrc.ucsd.edu>), a project in Louisiana in response to Hurricane Katrina, and IGPP-led field work in the Imperial Valley (<http://sopac.ucsd.edu/projects/impvall2008.html>).

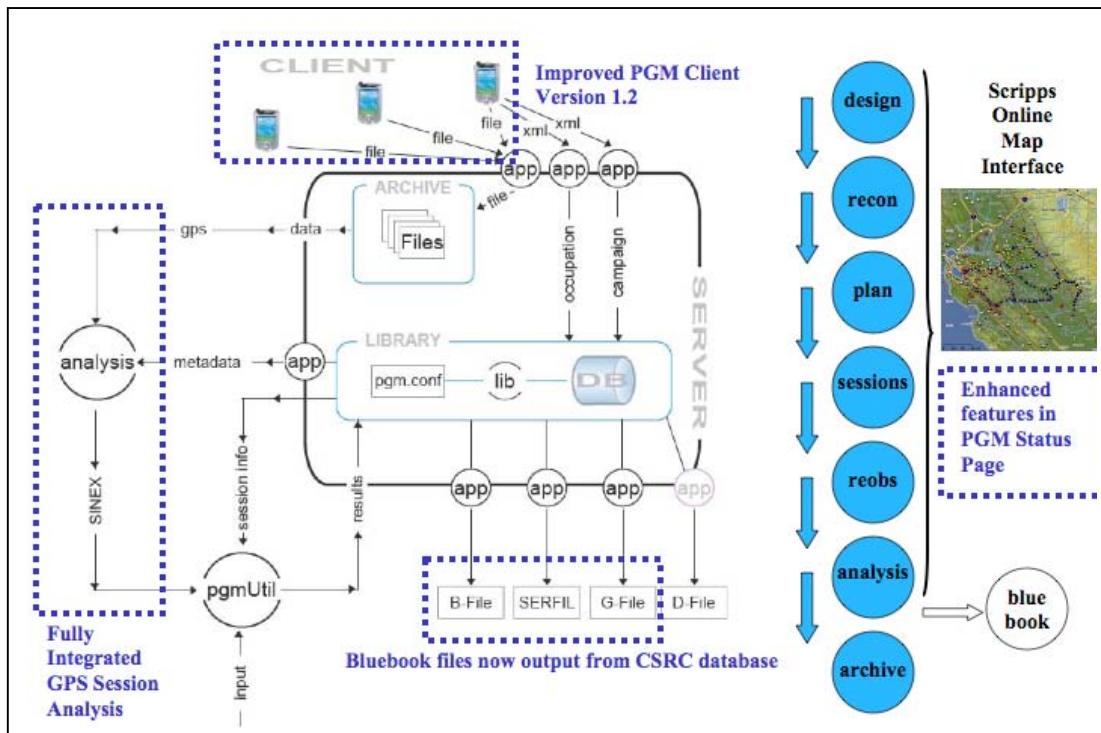

Recent Publications:

- Aydin, G., Z. Qi, M. E. Pierce, G. C. Fox, and Y. Bock (2007), Architecture, performance, and scalability of a real-time global positioning system data grid, *Phys. Earth and Planet. Interiors*, 163, 347-359, doi:10.1016/j.pepi.2007.04.012.
- Bassis, J. N., H. A. Fricker, H. A., R. Coleman, Y. Bock, J. Behrens, D. Darnell, M. Okal, and J.-B. Minster (2007), Rift propagation, seismicity and deformation associated with ice shelf rift propagation, *J. Glaciology*, 53(7), 523-536.
- Kogan, M. G., W.-Y. Kim, Y. Bock, and A. W. Smyth (2008), Load response on the Verrazano Narrows Bridge during the NYC Marathon revealed by GPS and accelerometers, *Seismo. Res. Lett.*, 79(1), 12-19.
- Luttrell, K., D. Sandwell, B. Smith-Konter, B. Bills, and Y. Bock (2007), Modulation of the earthquake cycle at the southern San Andreas fault by lake loading, *J. Geophys. Res.*, 112, B08411, doi:10.1029/2006JB004752.
- Mattia, M., M. Palano, M. Aloisi, V. Bruno, and Y. Bock (2008), High rate GPS data on active volcanoes: An application to the 2005-2006 Mt. Augustine (Alaska, USA) eruption, *Terra Nova*, 20, 134-140, doi: 10.1111/j.1365-3121.2008.00798.x.
- Wdowinski, S., B. Smith, Y. Bock, D. Sandwell (2007), Diffuse interseismic deformation across the Pacific-North America plate boundary, *Geology*, 35(4), doi:10.1130/G22938A.1, 311-314.

Catherine Constable
Professor of Geophysics
 Email: cconstable@ucsd.edu
 Phone: 858 534 3183

Research interests: Paleomagnetism and geomagnetism, applied to study of long and short term variations of the geomagnetic field; inverse problems; statistical techniques; electrical conductivity of the mantle; paleo and rock magnetic databases

Three ongoing research projects are targeting (i) geomagnetic field behavior during the Holocene time period (post doc, Fabio Donadini, and collaborator Monika Korte of GeoForschungs Zentrum, Potsdam), (ii) the magnetic field on million year time scales (PhD student Leah Ziegler, and Adjunct Professor Catherine Johnson) and (iii) electromagnetic induction studies from low-Earth-orbiting satellites (PhD students, Joseph Ribaud and Lindsay Smith). Other work includes the development with Anthony Koppers and Lisa Tauxe of flexible digital data archives for magnetic observations of various kinds under the MagIC (Magnetics Information Consortium) database project.

The Holocene Geomagnetic Field: The geomagnetic field has been measured at a variety of locations ever since the development of the first compasses, and direct observations on Earth's surface and (more recently) from low-earth orbiting satellites have led to excellent time-varying descriptions of the field for the past 400 years. Our recent work has focussed on improving the quality of millennial scale time varying geomagnetic field models for the past 3 kyr and extending existing models back to 10kyr. Major effort has been invested in compiling and evaluating comprehensive paleomagnetic data sets; new models for 0-3 ka also incorporate constraints from the 1590-1990 AD era of direct observations. The results of these endeavors are now being used to study the evolution of the South Atlantic Anomaly, currently manifest as a region of unusually low field strength, and to evaluate the significance of some apparently rapid changes in the field that have been named archeomagnetic jerks.

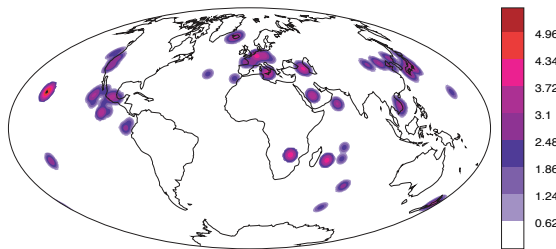

Figure 1(a) 0-1 Ma Global Paleointensity Distribution

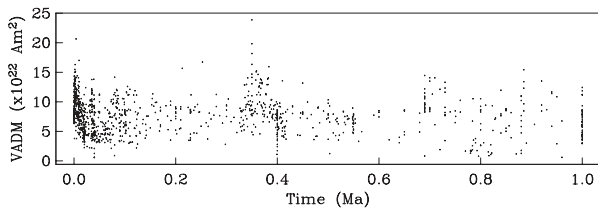

Figure 1(b) 0-1 Ma Temporal Paleointensity Distribution

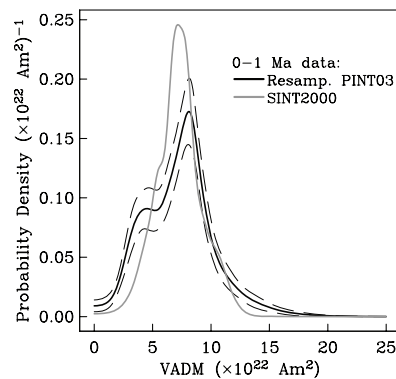

Figure 2: PINT03 gives distribution, with dashed lines as 95% confidence bounds, of absolute paleointensity data for 0-1 Ma. SINT2000 curve reflects smoothed distribution from global averaged sediment records.

The Magnetic Field on Million year Time Scales: Graduate student Leah Ziegler has been investigating the feasibility of extending time-varying field models to much longer (million year) time scales by combining directional and relative paleointensity data from marine sediments, with directions and absolute paleointensity data recovered from lava flows. A first step in this process

has been a study of the robustness and limitations of the 0-1 Ma absolute paleointensity data. Figure 1 shows the global distribution of 0-1 Ma absolute paleointensity plotted as density of observations on a log scale. Red (purple) values show areas with a high (low) concentration of data. White areas have no data. In Figure 1(b) paleointensity data are converted to equivalent virtual axial dipole moment and plotted as a function of age. The uneven temporal and spatial sampling seen in Figure 1 has been evaluated, and the average paleomagnetic axial dipole moment over 0–1 Ma is $7.26 \pm 0.14 \times 10^{22} \text{ Am}^2$, but the distribution of moments has an unusual bimodal distribution arising from long term variations in the geomagnetic field. Similar structure is seen in subdued form in the globally-averaged record from sediments which typically average variations over as large a time interval as 30 kyr (Figure 2). Current work is focussed on calibrating individual relative paleointensity time series from marine sediments to recover continuous dipole moment variations for the 0–1 Ma time interval.

Electromagnetic Induction Studies Using Satellite Observations: Induced magnetic fields in Earth's crust and mantle arise from temporal variations in the external part of the magnetic field, and these can be investigated using both ground and satellite observations. Graduate student Joseph Ribaud is developing numerical tools for global geomagnetic induction modeling via a commercially-available, general purpose, finite element modeling package called FlexPDE that uses flexible, scripted, finite element models. The modeling is performed in both time and frequency domains, and has been validated against known solutions to 3D steady state and time-dependent problems. The strength of the magnetic field generated by the magnetospheric ring current is known to vary as a function of local time, giving it an asymmetric spatial structure. Electromagnetic C-responses estimated from satellite data under the assumption that primary and induced fields are symmetric in structure are known to be biased with respect to local time, leading to associated uncertainties in mantle electrical conductivity. The scripted programming approach allows forward modeling of the global induction problem with realistic primary field structure, 3D Earth conductivity, and rotation, to study the influence on C-responses and provides for ready visualization of magnetic and electric fields throughout the modeling domain.

Relevant Publications

- Korte, M., & C.G. Constable, Spatial and temporal resolution of millennial scale geomagnetic field models, *Advances in Space Research*, 41, 57–69, doi:10.1016/j.asr.2007.03.094, 2008.
- Johnson, C.L., C.G. Constable, L. Tauxe, R. Barendregt, L.L. Brown, R. Coe, P. Layer, V. Mejia, N.D. Opdyke, B. Singer, H. Staudigel, & D. Stone, Recent Investigations of the 0-5 Ma Geomagnetic Field recorded by Lava Flows, *Geochem. Geophys. Geosyst.*, 9, Q04032, doi:10.1029/2007GC001696, 2008.
- Genevey, A., Y. Gallet, C.G. Constable, M. Korte, & G. Hulot, An upgraded compilation of geomagnetic field intensity data for the past ten millennia, *Geochem. Geophys. Geosyst.*, 9, Q04038, doi:10.1029/2007GC001881, 2008.
- Ziegler, L., C.G. Constable, & C.L. Johnson, Testing the robustness and limitations of 0–1 Ma absolute paleointensity data, *Phys. Earth Planet. Inter.*, 170, 34–45, doi:10.1016/j.pepi.2008.07.027, 2008.
- Gee, J.S., L. Tauxe, & C. Constable, AMSSpin – A LabVIEW program for measuring the anisotropy of magnetic susceptibility, *Geochem. Geophys. Geosyst.*, 9, Q08Y02, doi: 10.1029/2008GC001976, 2008.

Steven Constable
Professor of Geophysics

Email: sconstable@ucsd.edu
Phone: 42409



Research interests:

Marine EM methods, conductivity of rocks, satellite induction studies

Steven Constable is the lead PI for the SIO Marine EM Laboratory, which currently consists of project scientist Yuguo Li, postdoctoral scholar Kerry Key, and PhD students Karen Weitemeyer, David Myer, and Brent Wheelock. Kerry has accepted an Assistant Research Scientist position at IGPP, effective Fall 2008, so next year his work will be represented in the Annual Report under his own name.

As the name suggests, much of the lab's work is involved in developing and using marine EM methods. In August this year we carried out marine magnetotelluric (MT) studies in India, in and around the Gulf of Kutch just south of Pakistan in the northwest corner of the country. The objective is to map sediments underneath basalts at the edge of the Deccan Traps. This was a challenging project to say the least. Tidal currents in the Gulf were very swift and often filled the seafloor instruments with sediment, weighing them down and preventing their release. We made 39 deployments and 32 recoveries, although one instrument was lost in the ship's propeller during recovery. Some instruments eventually shed the entrained sediment and floated to the surface, one of which we recovered at the end of the cruise and two of which were recovered by fishermen after we left the project. Work to interpret the data is ongoing.

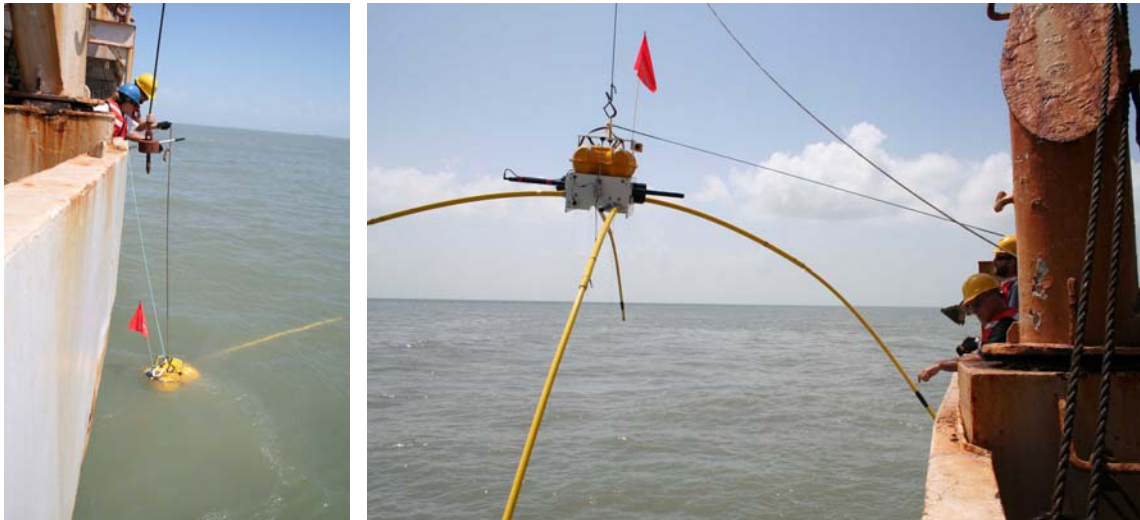

Figure 1. Recovering seafloor MT instruments in the murky waters of the Gulf of Kutch.

Part of the funding for the group comes from a consortium of 32 oil companies (the Scripps Seafloor Electromagnetic Methods Consortium) which are interested in developing marine EM methods for offshore exploration. Many of our instrument trials for this work are carried out in the San Diego Trough, a 1,000 m deep graben with sedimented seafloor just a few hours transit from our marine facility in Point Loma. Over the years we have collected a useful suite of MT sties and controlled source EM (CSEM) data which we have used to image the geological structure of the Trough. One of the MT lines was co-located with a deep-towed gravity line collected in 1995 by Mark Zumberge and Jeff Ridgway (Mark's student at the time). The combined MT, CSEM, and gravity interpretations, along with a nearby USGS seismic reflection profile, are shown in Figure 2. The gravity, CSEM, and MT all agree on a sediment thickness in the Trough of about 3.5 km. Both the gravity and MT suggest that the Coronado Bank is a sedimentary, rather than basement, feature.

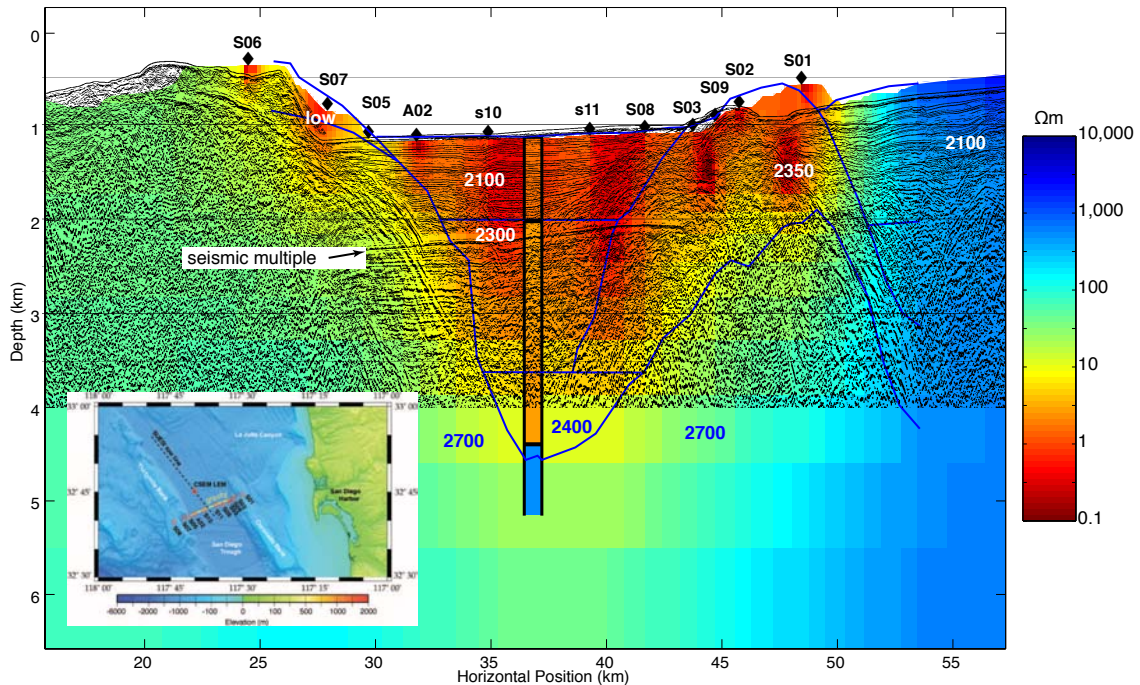

Figure 2. Image of the San Diego Trough obtained from marine EM, gravity, and seismic data. The color map is an inversion of MT data from sites S01 to S06. The vertical color bar is a 3-layer model based on a marine CSEM sounding oriented along the axis of the Trough. Blue overlay is a gravity model from Ridgway and Zumberge, along with densities in kg/m^3 . From Constable *et al.* (2008).

The three technicians and two engineers who work in the Marine EM Laboratory have spent much of the year developing, building, and testing instruments for an upcoming series of cruises in the Gulf of Mexico and offshore California. The first project, to be carried out during October in the Gulf, is to map gas hydrate in the seafloor. There is much interest in marine hydrates, since they may variously be viewed as a hydrocarbon resource, a source of greenhouse gases, and a natural hazard. However, very little is known about the total amount of hydrate stored in marine sediments, and EM methods may be the only way of assessing this (the hydrate is more resistive than the host sediments). The second project is to augment a land MT survey being carried out by German colleagues to study the San Andreas fault zone near Parkfield. During November–January we will extend the land arrays 200 km offshore to study the interaction of the stalled slab and underplated crust with the plate boundary fault zone. One hypothesis is that fluids migrating into the base of the fault are responsible for non-volcanic tremor observed near Parkfield.

Further information can be found at the lab's website, <http://marineemlab.ucsd.edu/>

Relevant Publications

Constable, S., Geomagnetism, in *Treatise on Geophysics, Volume 5*, edited by G. Schubert and M. Kono, Elsevier, doi:10.1016/B978-044452748-6.00092-4, 237–276, 2007.

Li, Y., and J. Pek, Adaptive finite element modeling of two-dimensional magnetotelluric fields in general anisotropic media, *Geophysical Journal International*, accepted, 2008.

Constable, S., K. Key, and L. Lewis, Mapping offshore sedimentary structure using electromagnetic methods and terrain effects in marine magnetotelluric data, *Geophysical Journal International*, accepted, 2008.

J. Peter Davis

Specialist

Email: pdavis@ucsd.edu

Phone: 4-2839

Research Interests: time series analysis, geophysical data acquisition

Peter Davis's research responsibilities at IGPP center upon monitoring the scientific performance of [Project IDA's](#) portion of the [Global Seismographic Network](#) (GSN), a collection of 41 seismographic and geophysical data collection stations distributed among 25 countries worldwide. IDA's core philosophy that data integrity may best be maintained by keeping network managers in close contact with data consumers has proven well-justified over the 30+ years of IDA's existence. IGPP is the perfect venue for IDA personnel to interact directly with many scientists who use GSN data on a daily basis.

The GSN is an ideal instrument for determining many of the Earth's large-scale geophysical properties. Dr. Davis recently began collaboration with IGPP's Guy Masters to refine measurements of the frequency and attenuation rate of the Earth's radial normal modes. The huge Sumatra-Andaman Islands earthquake of 2004 excited these modes to amplitudes larger than ever observed by modern digital seismometers. Using GSN data, Davis and Masters measured the oscillation frequency of the gravest of them, ${}_0S_0$, to an accuracy of better than 1ppm. This value differs by 7 nHz from a value that has remained unchallenged since it was published 28 years ago in the Ph.D. thesis work of an IGPP graduate student, Mark Riedesel. Knowing the frequency of ${}_0S_0$ more accurately will place tighter constraints on large-scale Earth models.

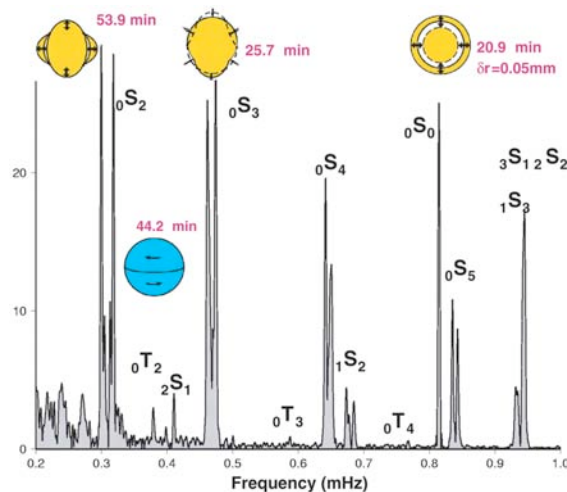

Figure 1. Schematic of the motion of free oscillations ${}_0S_2$, ${}_0T_2$, ${}_0S_3$, and ${}_0S_0$ superimposed on a spectrum computed from 240 hours of vertical seismic data recorded at Geoscope station CAN (Canberra, Australia) following the Sumatra-Andaman Isl. earthquake. Figure from Park *et al.* (2005b), courtesy of G. Roullet.

Some of Peter Davis's other recent work utilized tidal signals to evaluate the accuracy of instrument response information published by the GSN. Investigators use this information to remove from recorded data the frequency-dependent sensitivity of sensors so that they may study true ground motion and its underlying physical causes. All GSN network operators including IDA supply this response information along with the seismological time series. Because tides are a continuous background signal observable at nearly all GSN stations not at

high latitudes, they are ideal for checking the validity of instrument response over the lifetime of the network. Using information collected by satellites about tidal flow of water in the ocean basins, scientists can now model the effect of tides very accurately at any point on the Earth's surface. With programs provided by Duncan Agnew of IGPP, Pete computed the tidal signal at all GSN stations to the accuracy required for validating their reported instrument response.

This technique was useful both for checking instrument response and for examining long term behavior of the network's sensors. Figure 2 shows results for station PFO, the GSN station locally operated by IGPP. As the IDA flagship station, this site serves as a testbed for all new generations of devices to be deployed throughout the network, so equipment turnover is particularly high here. Data segments varying from 60-180 days were used to compare the recorded tidal signal with what was predicted from the ocean models. If the computations agreed, all points should have unity relative amplitude in this plot. For PFO, this ideal was approached from mid-2002 onward. In the first half of the decade, the results were close but slightly higher, then lower than what is desirable. Late in 2001, the published response information was highly inaccurate and will have to be corrected.

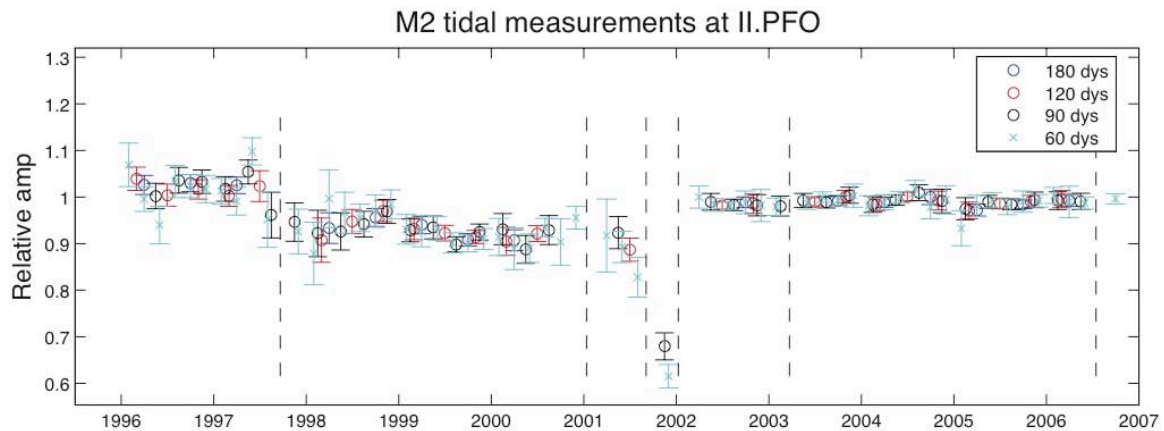

Figure 2: Measurements of the relative amplitude (ratio of observed to predicted amplitude) of the principal lunar tide M2 at GSN station PFO (Pinyon Flat, CA). Vertical dashed lines represent times when equipment was changed and a re-calibration procedure, performed.

Relevant Publications

- Davis, P., and J. Berger, Calibration of the Global Seismographic Network using tides, *Seis. Res. Lett.*, **78**, 454-459, 2007.
- Davis, P., M. Ishii and G. Masters, An assessment of the accuracy of GSN sensor response information, *Seis. Res. Lett.*, **76**, 678-683, 2005.
- Park, J., R. Butler, K. Anderson, J. Berger, H. Benz, P. Davis, C.R. Hutt, C.S. McCreery, T. Ahern, G. Ekström, and R. Aster, Performance review of the Global Seismographic Network for the Sumatra-Andaman megathrust earthquake, *Seis. Res. Lett.*, **76**, 331-343, 2005.
- Park, J., T.-R. Song, J. Tromp, E. Okal, S. Stein, G. Roullet, E. Clevede, G. Laske, H. Kanamori, P. Davis, J. Berger, C. Braitenberg, M. Van Camp, X. Lei, H. Sun, H. Xu and S. Rosat, Earth's free oscillations excited by the 26 December 2004 Sumatra-Andaman earthquake, *Science*, **308**, 1140-1144, 2005.
- Berger, J., P. Davis, and G. Ekstrom, Ambient Earth Noise: a survey of the Global Seismic Network, *J. Geophys. Res.*, **109**, B11307, 2004.

Catherine de Groot-Hedlin

Associate Project Scientist, email: chedlin@ucsd.edu, Phone extension: 4-2313

Research Interests: Acoustic propagation modeling with application to infrasound and hydroacoustics; application of hydroacoustics and infrasound to nuclear test-ban verification; use of dense seismic networks to analyze infrasound signals; application of infrasonic signals to hazard monitoring.

Infrasound: A primary goal in infrasound research is to understand the transmission of infrasound - sound at frequencies lower than human hearing - to distances of several hundreds to thousands of kilometers; a task complicated by the fact that propagation of sound depends on variable winds and atmospheric temperatures. de Groot-Hedlin is the sole-PI on a project to develop numerical methods to compute infrasound propagation through realistic atmospheric conditions. She is co-PI on other projects to investigate infrasound propagation from various sources, including natural hazards.

Atlantis study: A recent study to make use of the dense networks in the western United States was an infrasound analysis of the re-entry of the space shuttle Atlantis by de Groot-Hedlin et al. (2008a). Space shuttles usually land at the Kennedy Space Center in Florida, but severe weather in that area on June 22, 2007 forced NASA to direct Atlantis to the alternate landing site at Edwards Air Force Base in the Mojave Desert in southern California. On its approach, the shuttle passed just west of Baja California and then across San Diego and Los Angeles before passing below the sound barrier over the Mojave Desert. The sonic boom was heard by millions of people and the infrasound generated by the shuttle was examined at over three hundred three-component seismic stations in the USArray, various regional seismic networks and three infrasound stations in southern California and western Nevada. The temporary presence of the transportable USArray in this region provided this study with a much broader and denser array of sensors than would otherwise be available. A GPS receiver onboard the space shuttle recorded the shuttle's position and time along its trajectory, yielding a rare opportunity to evaluate present-day atmospheric models over a dense network using infrasound signals for a source with a known time and location.

Over one hundred seismic sensors and all three infrasound stations recorded the signal. For comparison, travel times were predicted using rays propagated through atmospheric specifications provided by a wind and temperature model provided by the Naval Research Labs. Observed arrival times are compared to predicted arrival times in the figure below. Comparison of predicted versus observed travel times shows agreement over much of the study area. To the east of the shuttle trajectory, there were no detections beyond the primary acoustic carpet, but infrasound energy was detected hundreds of kilometers to the west and northwest of the shuttle trajectory, consistent with the predictions of ducting due to the westward summer-time stratospheric jet. To the northwest, regions of ensonification are predicted to alternate with shadow zones. However, infrasound energy was detected to up to twenty kilometers within predicted shadow regions.

Figure caption a) Map of stations used in the study by de Groot-Hedlin et al. (2008a). Filled circles indicate seismic and infrasound stations that recorded an arrival, color-coded according to observed first arrival time, in seconds after 1900 GMT. For comparison, the shuttle speed drops below Mach 1 at 2732 s after 1900 GMT. The supersonic portion of the shuttle trajectory is shown in red. Empty circles indicate station locations where signal were not detected. b) Map of ray endpoints that reach the ground, for rays starting along the supersonic portion of the shuttle trajectory. Only stratospheric and tropospheric arrivals were considered. The endpoints are color-coded according to the predicted arrival time. Empty circles mark stations where signals were not observed. Filled circles indicate stations where arrivals were detected.

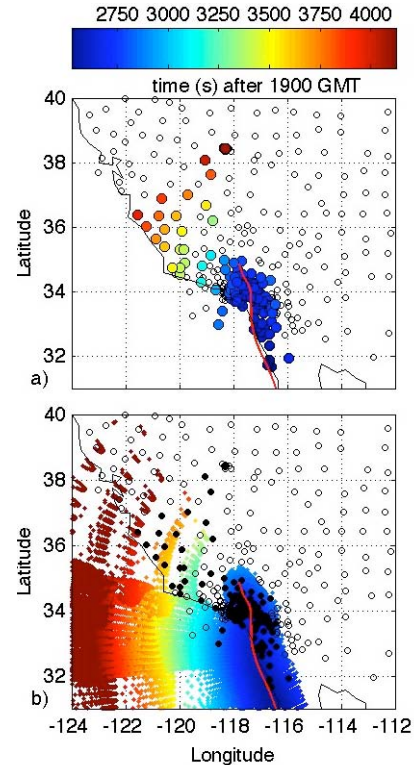

Hydroacoustics: Catherine de Groot-Hedlin is co-PI with Donna Blackman on an investigation of the propagation of hydroacoustic energy through the Antarctic Convergence Zone (ACZ), the site of a sharp discontinuity in acoustic velocity. Propagation of hydroacoustic energy through this region is of interest for the purpose of developing a worldwide nuclear test-ban monitoring system.

A research cruise was conducted in December 2006, along a transit from Christchurch, New Zealand to McMurdo station in the Antarctic. A number of explosive charges with sizes from 2 to 12 lb were fired at depths from 300m to 600m. These shots were recorded at several hydroacoustic stations that form a part of the International Monitoring System (IMS) at distances of 5000 to 9000km from the source. Our results show that changes in the signal duration and average sound velocity from shots in the ACZ varies with latitude.

Relevant Publications

- de Groot-Hedlin, C.D., M.A.H. Hedlin, K.T. Walker, D. D. Drob, and M.A. Zumberge, Evaluation of infrasound signals from the shuttle Atlantis using a large seismic network, *J. Acoust. Soc. Am.*, **124**, 1442-1451, (2008a)
- de Groot-Hedlin, C.D., Finite-difference synthesis of infrasound propagation through an absorbing atmosphere, *J. Acoust. Soc. Am.*, **124**, 1430-1441, (2008b)
- de Groot-Hedlin, C.D., D.K. Blackman, and C.S. Jenkins. Effects of variability associated with the Antarctic Circumpolar Current on sound propagation in the ocean, 29th Monitoring Research Review, 30, Portsmouth, Virginia, (2008c)
- Herrin, E.T., Bass, H.E., B. Andre, R.L. Woodward, D. D. Drob, M.A.H. Hedlin, M.A. Garces, P.W. Golden, D.E. Norris, C.D. de Groot-Hedlin, K.T. Walker, C.A. L. Szurbela, R.W. Whitaker, and F.D. Shields, High-altitude infrasound calibration experiments, *Acoustics Today*, 4, 9-21, (2008)

Matthew Dzieciuch
Project Scientist
Email: mad@ucsd.edu
Phone: 4-7986

Research interests: ocean acoustic tomography, signal processing

Philippine Sea Experiment

Over the past year I have been participating in the planning for a new ocean acoustic tomography experiment. The experiment has been funded by the Office of Naval Research and will take place in the Philippine Sea starting in 2009 and ending in 2011. The experiment takes place in a challenging and dynamic part of the ocean, which is located near, but not in the origin of a major western boundary current, the Kuroshio. The location of the acoustic array is shown in the figure. The program has two main goals, one is oceanographic in nature, and the second explores acoustic issues.

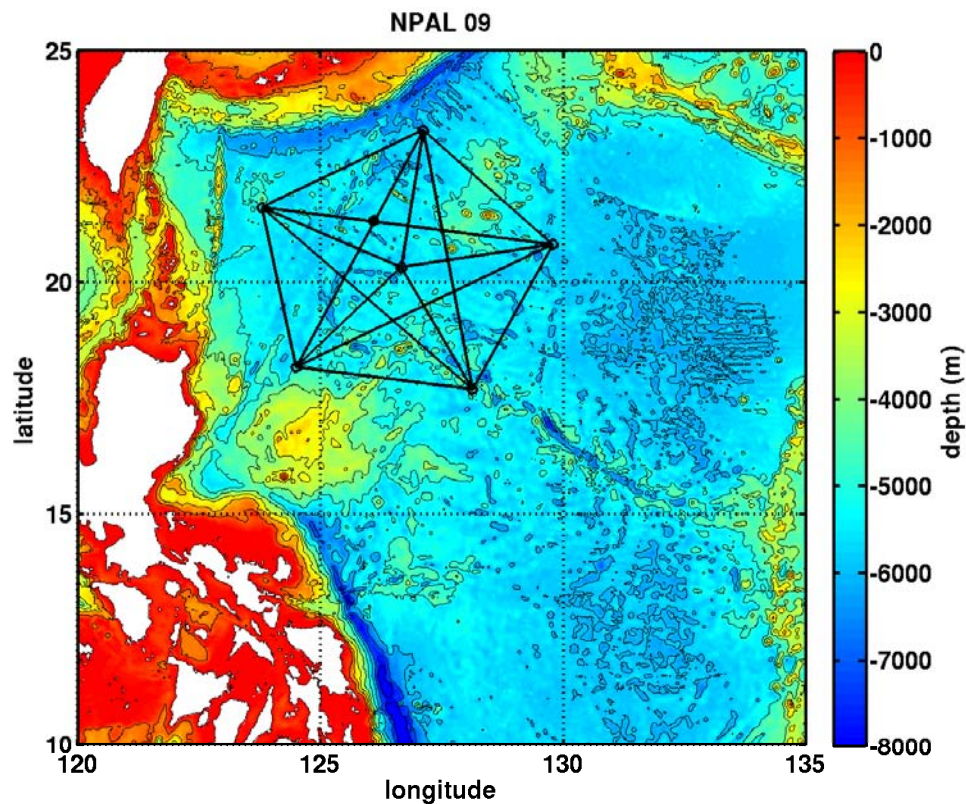

Figure 1: Plan view of the experimental configuration. The black dots show locations of moorings and the lines show acoustic paths between them.

It has been speculated and results from recent modeling work (see the first paper referenced below) confirm that ocean basin western boundary currents radiate barotropic waves that carry a large amount of energy with them. These are difficult to detect with standard oceanographic instrumentation but should be possible to detect with a tomographic array like the one that we have designed. A secondary purpose is to find the limits of ocean model predictability given the strong constraints of the tomography data and thus improve model performance.

The second goal is to continue to explore the limits of ocean acoustic systems whose time and space coherence scales are limited by the ocean's dynamics. Since this experimental location is in a much more energetic location than previous ones in the North Pacific, it will be interesting to see how stable the acoustic paths are in this area. Differences in stratification, and increased mesoscale energy, are expected to strongly influence the results.

Finally, the experiment is has a interesting technology challenge. One of the moorings will include more than 100 internally-recording autonomous hydrophones on a vertical line array. The independent units will run for one year on a single DD-cell battery and be capable of recording 16 Gbytes of acoustic data. This is made possible by the continued miniaturization of modern electronics.

Recent publications:

Miller, A.J., Neilsen, D.J., Luther, D.S., Hendershott, M.C., Cornuelle, B.D., Worcester, P.F., Dzieciuch, M.A., Dushaw, B.D., Howe, B.M., Levin, J.C., Arango, H.G., and Haidvogel, D.B., Barotropic Rossby wave radiation from a model Gulf Stream, *Geophysical Research Letters*, **34** (23), [DOI 10.1029/2007GL031937], (2007).

Dzieciuch, M., W. Munk, and D. Rudnick, Propagation of sound through a spicy ocean, the SOFAR overture, *J. Acoust. Soc. Am.*, **116**, 1447-1462, (2004).

Dzieciuch, M., P. Worcester, and W. Munk, Turning point filters: Analysis of sound propagation on a gyre-scale, *J. Acoust. Soc. Am.*, **110**, 135-149, (2001).

Yuri Fialko
Associate Professor
Email: yfialko@ucsd.edu
Phone: 2-5028

Research interests: earthquake physics, crustal deformation, space geodesy

Yuri Fialko's research is focused on understanding the mechanics of seismogenic faults and magma migration in the Earth's crust, through an application of the principles of continuum and fracture mechanics to earthquakes and volcanic phenomena. Prof. Fialko is using observations from space-borne radar satellites, including the ERS and ENVISAT satellites of the European Space Agency, and the ALOS satellite of the Japanese Space Agency, as well Global Positioning System, to investigate the response of the Earth's crust to seismic and magmatic loading. Figure 1 shows the results of a recent study of the aftermath of a large (magnitude 7.3) strike-slip earthquake that occurred in 2003 on the Russia-China border. Analysis of radar interferograms collected by the ENVISAT satellite over 3 years following the mainshock reveals lobes of line-of-sight displacements near the rupture trace that are indicative of a relatively shallow source. The data are best explained by a post-seismic slip on the earthquake rupture (either in the form of aseismic creep, or aftershocks), which anti-correlates with the coseismic slip (that is, afterslip is small in areas of high coseismic slip, and is maximum on the periphery of areas with high coseismic slip). The bottom panel of Figure 1 shows the best-fitting afterslip model (with red color representing enhanced postseismic slip, and blue color representing no slip), along with the predicted surface displacements. Surprisingly, the space geodetic data showed that there has been relatively little, if any, poroelastic deformation due to migration of pore fluids at depth. The data also rule out a robust viscoelastic relaxation in the lower crust. These findings indicate that the postseismic response following major crustal earthquakes may not be readily predictable, and likely involves multiple mechanisms.

Over the recent years, there were a number of intriguing reports of "silent" slip events in various subduction zones around the world. These slip events appear to occur quasi-periodically at the bottom of the seismogenic zone, near the transition between the velocity-weakening part of the subduction zone interface (that remains locked in the interseismic period and slips primarily in great earthquakes) and the underlying velocity-strengthening interface (which undergoes a stable creep in the postseismic period). In

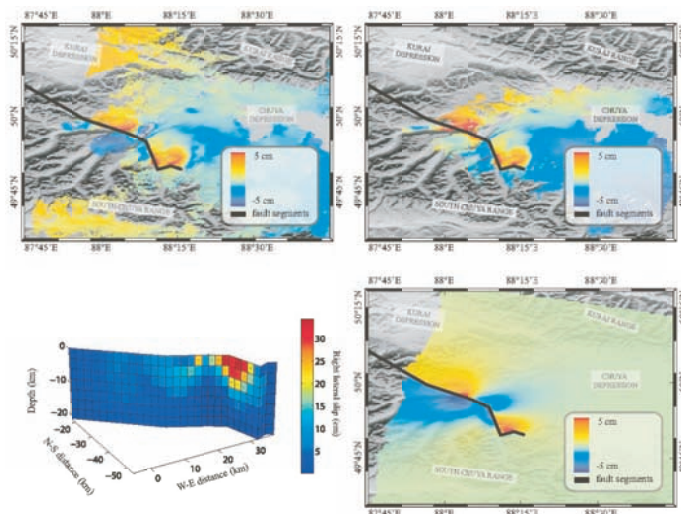

Figure 1: Radar interferogram of post-seismic relaxation due to the M7.3 Altai (Russia) of 2003, and the best-fitting model. The data can be explained with afterslip on the earthquake rupture; the post-seismic slip on the fault is inferred to "fill in" the gaps left behind by the main rupture.

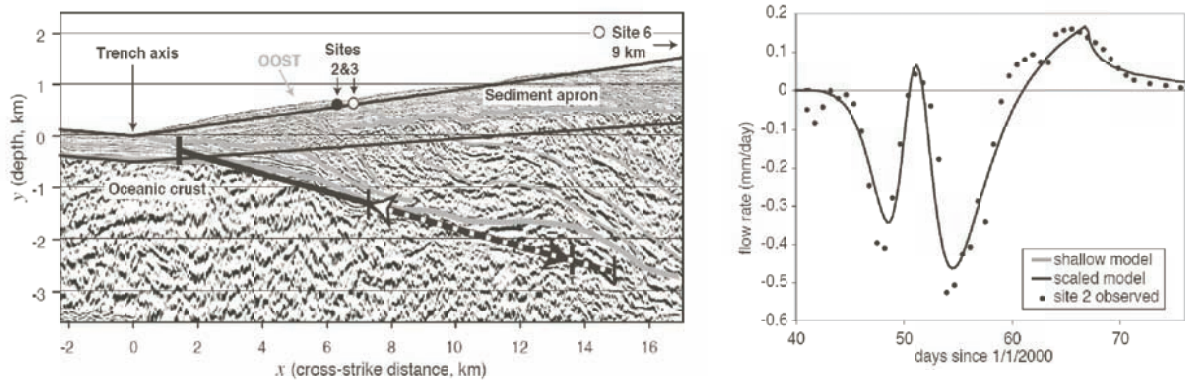

Figure 2: (Left) Seismic reflection profile and flow meter locations. Grey lines are inferred fault locations. The February time series at Site 2 is reproduced with a down-dip propagating rupture (best-fit model shown by a solid black arrow). The time series recorded at Site 3, 15 km along-strike to the northwest, is modeled with an up-dip propagating rupture on the decollement (dashed line and outlined arrow). (Right) Observed (dots) and modeled (solid line) fluid flow across the seafloor for Site 2 February time series (background flow rate removed).

collaboration with Prof. Kevin Brown and graduate student Alison LaBonte, Prof. Fialko investigated anomalous transient fluid flux through the seafloor recorded near the Costa Rica trench during the 2000 Costa Rica Seismogenic Zone Experiment. It was hypothesized that the observed hydrogeologic anomalies result from a propagating slow slip at the subduction interface between the frontal prism and downgoing plate. Figure 2 shows a seismic cross-section indicating a position of the subduction interface, the instrument locations, and the modeled “silent rupture” (left panel), as well as the observed fluid flow through the seafloor, and the model prediction (right panel). By comparing the observed fluid flow transients to our finite element simulations, we are able to infer the probable rupture location, extent, propagation rate, and duration. The best-fit model suggests that the slow-slip event initiated within the toe at a depth of less than 4 km, and propagated bi-laterally at an average rate of 0.5 kilometers per day. This interpretation implies that stress in the shallow subduction zone is relieved episodically. Furthermore, the Costa Rica data suggest that episodic slow-slip events may initiate in the prism toe without being triggered by a seismic event further down-dip.

Recent publications:

- Barbot, S., Y. Hamiel and Y. Fialko, Space geodetic investigation of the coseismic and postseismic deformation due to the 2003 M(w)7.2 Altai earthquake: Implications for the local lithospheric rheology *J. Geophys. Res.*, 113, B03403, 2008.
- Barbot S., Y. Fialko and D. Sandwell, Effect of a compliant fault zone on the inferred earthquake slip distribution, *J. Geophys. Res.*, 113, B06404, 2008.
- LaBonte, A., K. Brown and Y. Fialko, Hydrologic detection and finite-element modeling of a slow-slip event in the Costa Rica prism toe, *J. Geophys. Res.*, in press.
- Barbot, S., Y. Fialko and Y. Bock, Postseismic deformation due to the Mw6.0 2004 Park-field earthquake: Stress-driven creep on a fault with spatially variable rate-and-state friction parameters, *J. Geophys. Res.*, in press.

Helen Amanda Fricker

Associate Profesor

Email address: hafricker@ucsd.edu

Phone extension: 46145

Research Interests: cryosphere, Antarctic ice sheet, subglacial lakes, ice shelves, satellite laser altimetry

Helen Amanda Fricker's main research focuses on the Earth's **cryosphere**, in particular the **Antarctic ice sheet**. One of the primary questions in Antarctica is whether its mass is changing due to climate change. Due to the vast size of the ice sheet, and the long time periods over which it can change, satellite data are crucial for routine monitoring, in particular data from radar and laser altimetry, and also imagery. Since the launch of NASA's Ice, Cloud and land Elevation Satellite (ICESat) in January 2003 Helen has used data from the Geoscience Laser Altimeter System (GLAS) on ICESat, which provides accurate elevation data for ice sheet change detection. She has been affiliated with the ICESat Science Team since 1999 and was made a Team Member in April 2006. She is also a member of the ICESat-II ad-hoc Science Definition Team.

Antarctic subglacial water: In 2006 Helen and her colleagues discovered active subglacial water systems under the fast-flowing ice streams of Antarctica using ICESat data. They found large elevation change signals in repeat-track ICESat data (up to 10m in some places) corresponding to draining and filling of subglacial lakes beneath 1-2 km of ice. Changing the basal conditions of an ice sheet, particularly beneath fast flowing ice streams and outlet glaciers, is one possible mechanism to increase its contribution to sea level rise, through increased ice flow rates in the ice streams. The fact that water moves so rapidly in such large volumes implies that ice stream dynamics can change rapidly also, which affects how fast the ice flows from the continent. With the current interest in Antarctic ice sheet mass balance and its potential impact on sea-level rise, it is important to understand the subglacial water process so that it can become incorporated into models. Since the original paper on this work, documented in a 5-page Research Article in *Science*, Helen and her team have continued to monitor ice stream lakes. Figure 1 shows the dramatic drainage event of Subglacial Lake Conway in 2006 (Fricker and Scambos, in review).

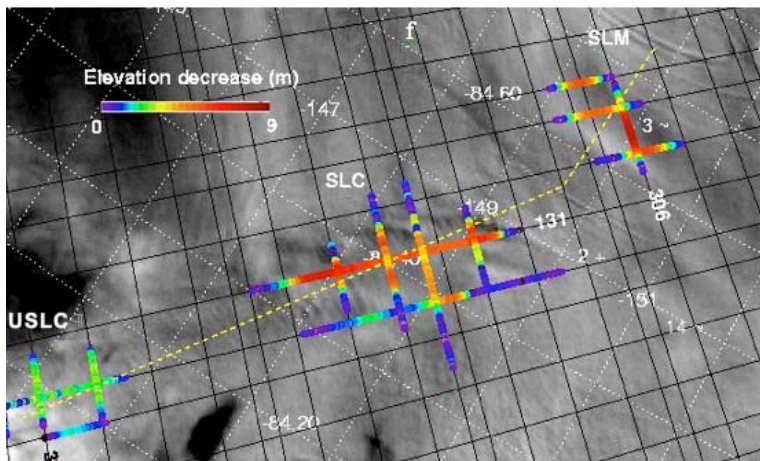

Figure 1. MODIS difference image for the period Nov 2007-Nov 2005 over three linked lakes ([U]SLC; [Upper] Subglacial Lake Conway, SLM; Subglacial Lake Mercer). ICESat tracks are shown as black lines and coloured track segments represent the elevation decrease over approximately the same 2 year period.

Ice shelf grounding zones: Helen also uses ICESat data to map the grounding zones of the ice shelves - the dynamically-active transition zones between grounded and floating ice. Grounding zones (GZ) are important because they are the gateway through which ice flows off the grounded ice sheet into the ice shelves and ultimately to the ocean. Monitoring the GZ is therefore an important part of ice sheet change detection, the primary objective of the ICESat mission. Her analysis of data from repeated tracks, sampled at different phases of the ocean tide, has shown that ICESat can “see” the tide-forced flexure zone between fully grounded continental ice and fully floating ice shelf ice, identifying the landward and seaward limits of ice flexure, providing accurate GZ location and width information for each track. Helen and postdoctoral researcher Kelly Brunt are using this new technique to map the GZ for large parts of the ice sheet (Ross Ice Shelf, Amery Ice Shelf and Filchner-Ronne Ice Shelf). This combined with surface elevation at the grounding lines will contribute to improved calculations of the ice sheet’s mass balance.

Glacio-seismology: In 2008 Helen started a new NSF project with Jeremy Bassis and Shad O’Neel (both ex-IGPP postdocs) investigating the source processes for seismic signals recorded in three different glaciological environments: the Amery Ice Shelf; the Ross Ice Shelf; and Columbia Glacier, Alaska.

Publications 2007-08

FRICKER, H.A. and T.A. SCAMBOS (in review) Interlinked subglacial lake activity on lower Mercer and Whillans ice streams 2003-2008, submitted to *Journal of Glaciology* September 4th 2008.

BASSIS, J.N., **H. A. FRICKER**, R. COLEMAN, J-B MINSTER (2008) An investigation into the forces that drive ice-shelf rift propagation on the Amery Ice Shelf, East Antarctica, *Journal of Glaciology*, 54(184), 17-27.

BORSA, A. A. **H. A. FRICKER**, B. G. BILLS, J.-B. MINSTER, C. C. CARABAJAL, K. J. QUINN (2008) Topography of the salar de Uyuni, Bolivia from kinematic GPS, *Geophysical Journal International*, 172(1), 31-40.

BASSIS, J.N., **H. A. FRICKER**, R. COLEMAN, Y. BOCK, J. BEHRENS, D. DARNELL, J-B MINSTER (2007) Seismicity and Deformation Associated with Ice Shelf Rift Propagation, *Journal of Glaciology*, 53(183), 523-536.

BORSA, A. A. J.-B. MINSTER, B. G. BILLS, , **H. A. FRICKER** (2007) Modeling long-period noise in kinematic GPS applications, *Journal of Geodesy*, 81(2), DOI 10.1007/s00190-006-0097-x.

FRICKER, H.A., T. SCAMBOS., R. BINDSCHADLER, L. PADMAN (2007) An Active Subglacial Water System in West Antarctica Mapped from Space, *Science*, Research Article Published Online February 15, 2007 *Science* DOI: 10.1126/science.1136897.

BORSA, A. A., **H. A. FRICKER**, B. G. BILLS, J.-B. MINSTER, C. C. CARABAJAL, K. J. QUINN, Topography of the salar de Uyuni, Bolivia from kinematic GPS, *Geophysical Journal International*, accepted May 2007.

Alistair Harding

Research Geophysicist

Email: aharding@ucsd.edu

Phone: 44301

Research Interests: *Marine seismology, mid-ocean ridges, continental rifting, tectonic hazards in California*

Multichannel seismic (MCS) data is the most efficient means of mapping the presence of an axial magma chamber (AMC) beneath mid-ocean ridges: the reflection from the magma lens characteristically appearing as a bright, continuous event on along-axis sections. Information on the internal state of the magma lens can be obtained by careful analysis of the amplitude and the amplitude variation with offset (AVO) of the reflection. If the magma chamber is melt rich and effectively liquid, it will not support the transmission of shear waves and there will be a rapid variation of amplitude with offset. Conversely if the magma chamber is semi-rigid with interlocking crystals – a mush, it will support S-waves and the P-wave velocity is higher, resulting in a weak AVO behavior and a reduced reflection amplitude.

In this project we investigated two questions related to the internal state of the magma lens along the spreading centers of the Lau Back Arc basin. The first is to investigate whether there is a correlation between melt-rich zones and the location of high-temperature hydrothermal vents on the seafloor. Previous studies along the southern East Pacific Rise (*Singh et al*, 1998) and the Juan de Fuca ridge (*Canales et al*, 2006) suggest that such a correlation exists but, as yet, there is only limited data on this intriguing observation. The correlation might arise because the melt rich regions represent sections of the magma chamber that can sustain higher heat flow and thus tend to anchor the upwelling limbs of the hydrothermal systems. Thus state of the magma chamber may help to configure or reconfigure the hydrothermal circulation pattern within a ridge segment.

The second area of investigation was prompted by the results of *Collier & Sinha* (1992) who estimated reflection coefficients for the magma chamber reflection along a short interval of the Valu Fa Ridge (VFR), the southernmost spreading center in the Lau Basin and the one closest to to the volcanic arc. For the region between $\sim 22^{\circ} 23'S$ & $22^{\circ} 30'S$, the median reflection coefficient estimated by Collier & Sinha was -0.35 but values went as high as -0.65. This median value is considerably higher than the reflection coefficient of -0.2 estimated for the basaltic crust of the northern East Pacific Rise (*Vera et al*, 1992) and raises the possibility that these higher values are characteristic of the predominantly arc-like crust of the VFR. In particular, high reflection amplitudes could be indicative of high volatile content in the magma, resulting in either a reduction density or a sharp reduction in velocity due to exsolved gas in the melt (*Collier & Sinha*, 1992; *Morton & Sleep*, 1985). The highly vesicular nature of the rocks and the unusually low upper crustal velocities (*Jacobs et al*, 2007) are direct and indirect indicators of elevated volatile content in VFR magmas. However, with reflection coefficient estimates from only a limited geographic range it is hard to know whether the higher reflection coefficient estimates are representative of the VFR, or whether there are unrecognized biases in estimates from different investigators.

To address these questions, we looked AVO patterns and reflection amplitudes in MCS data for two segments of the ridge, the VFR and a transition segment between $20^{\circ} 33'S$ & $20^{\circ} 43'S$. This latter segment connects the northern and central Eastern Lau Spreading Center and marks the north-south transition from axial rift to axial high and the emergence of a near-continuous magma chamber reflector that continues south all the way to the tip of the VFR. Both segments have explored and potential hydrothermal vent sites (*Baker et al.*, 2006), and the transition segment is the focus of the R2K integrated study site in the Lau basin, Figure 1.

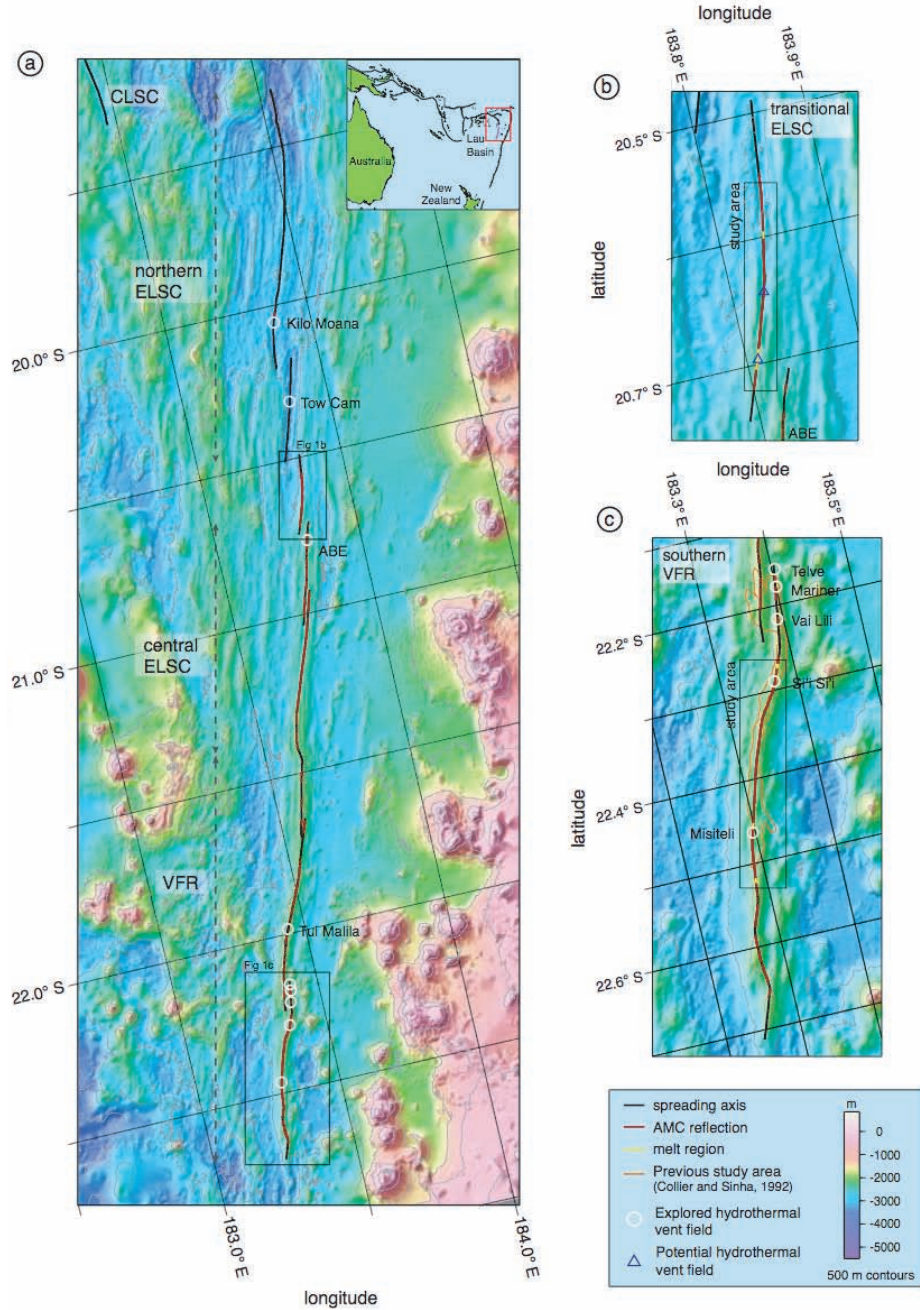

Figure 1: Map of the Eastern Lau Spreading Center/Valu Fa Ridge spreading system labeled by major sections (a). The Central Lau Spreading Center (CLSC) is labeled in northeastern corner. Solid black lines mark the spreading axes and where overlain with red, denote an axial magma chamber reflection is present. Yellow circles are the locations of explored hydrothermal vent fields from Baker et al.(2005, 2006). Black boxes show the transitional ELSC (tELSC) and southern VFR (sVFR). In the maps of the tELSC (b) and sVFR (c), yellow lines mark melt zones, while blue triangles denote areas of enhanced hydrothermal activity. Inset boxes show study sites. The region outlined in orange highlights the study area of Collier and Sinha (1992).

Data Processing

Although the basic processing sequence needed for the AVO analysis and the estimation of reflection coefficients is well established, we found that both needed to be enhanced and improved to cope effectively with the rougher seafloor of the ELSC/VFR. The rougher seafloor produces higher amplitude scattering that disrupts the continuity of the magma chamber reflections and can completely obscure the converted S-wave reflection from the top of the magma chamber – the PmeltS arrival that is one of the diagnostics of a melt-rich magma chamber. To improve the quality of the data, we used a combination of DMO and F-K filtering to suppress side-scatter from the seafloor (*Kent et al., 1996*). Since this process is most effective when the streamer is in-line with the profile, we checked streamer orientation to guard against excessive feathering.

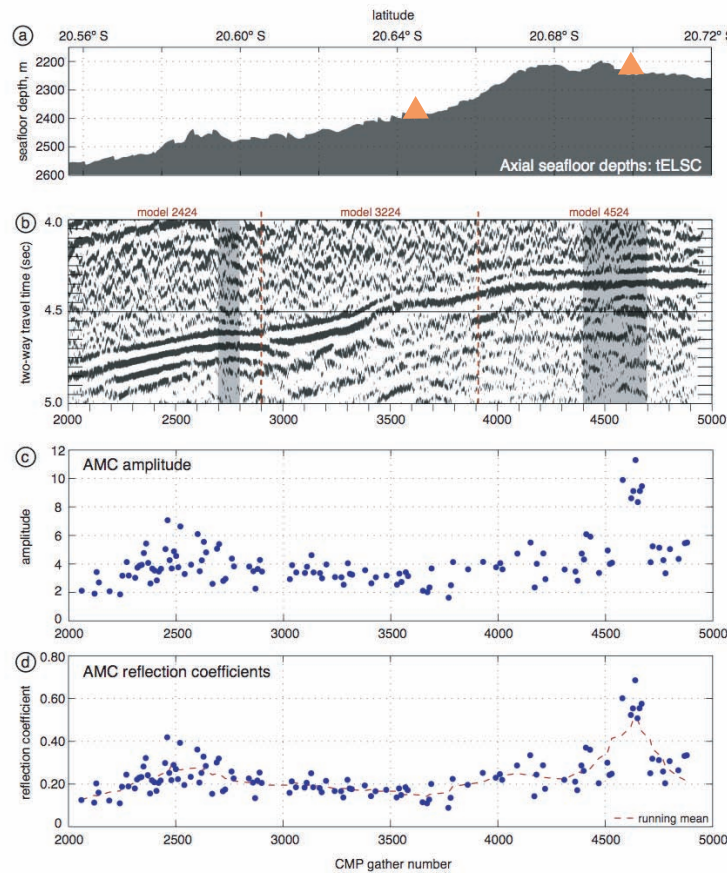

Figure 3: Plots of seafloor bathymetry (a), AMC reflection (b), AMC amplitude (c), and reflection coefficient (d) along the transition segment. Gray areas indicate melt regions. In part (d) the red dashed line is a running mean of the individual estimates, blue dots. The spike in amplitude and reflection coefficients correlate with a region of melt in one of the two locales imaged and to a potential site of hydrothermal venting.

The typical procedure for estimating reflection coefficients from MCS data has been to use the relative amplitudes of magma chamber, primary and multiple seafloor reflections after appropriate corrections (e.g. *Collier & Sinha, 1992*). Amplitudes are more susceptible than AVO patterns to scattering noise and are also sensitive, for example, focussing/defocussing by local seafloor variations. We applied cluster analysis (*Kauffman & Rousseeuw, 1991*) based on waveform cross-correlation to group the AMC reflection and winnow the data, keeping only the largest clusters with the cleanest wavelets. We also found that the estimates of source amplitudes made from seafloor primary and multiple reflections de-

creased rapidly with seafloor roughness. So, rather than using the axial profiles themselves, we estimated source amplitudes from reflections in sediment ponds near the ridge axis.

Results

The AVO analysis of the transition segment identified two melt areas at 20° 36' S and 20° 42' S, Figure 2. While the AMC reflection amplitudes have a distinct peak at 20° 42' S there is only a muted response near 20° 36' S, Figure 3. Based on water column mapping, there are 2 potential hydrothermal areas within this segment, one of which corresponds to the melt region at 20° 42' S. We see a similar pattern along the Valu Fa Ridge. The AVO analysis identifies 3 melt-rich regions, the largest of which at 22° 28' S has a high estimated reflection coefficient and corresponds to a known hydrothermal vent site, the Misiteli Field, Figure 1. A second melt-rich region is near but slightly north, ~1.3 km of the Si-Si field.

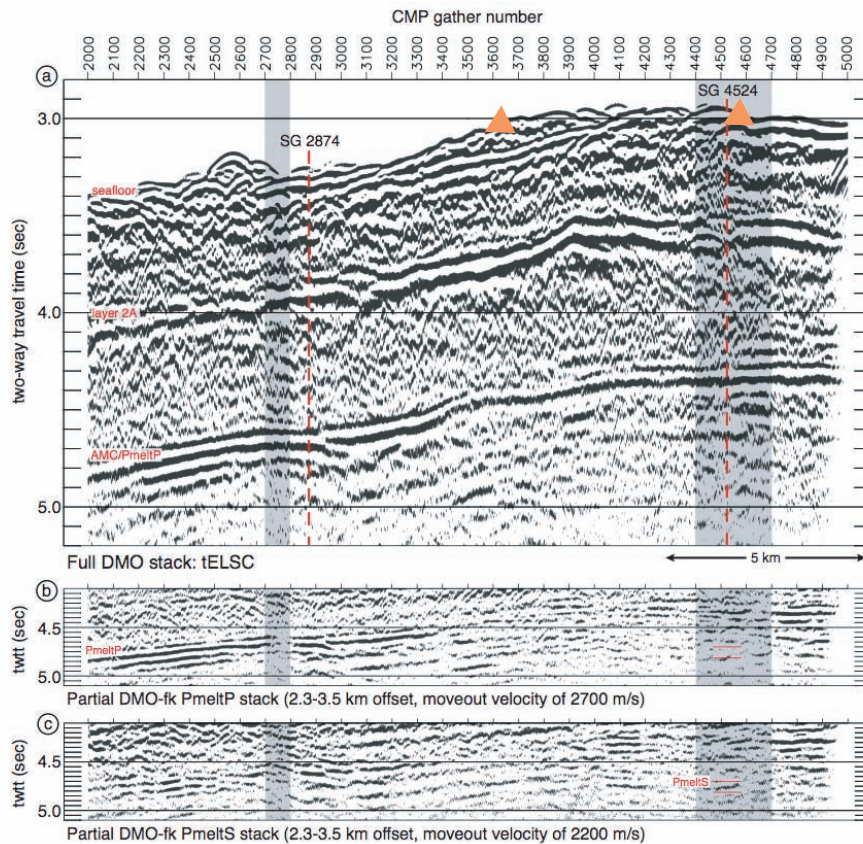

Figure 2: Along-axis stacked sections of the transition segment (a) Full-offset stack. Gray regions are melt-rich regions determined from AVO analysis. Panels (b) and (c) are partial offset stacks. Both include data from 2.3-3.5 km offset. PmeltP stack is moved out at 2700 m/s, while PmeltS stack is moved out at 2200 m/s. Red horizontal lines below SG 4524 show the PmeltS phase on (b) and its absence on (c). Orange triangles denote location of potential hydrothermal fields based on water column mapping by Baker et al. (2006).

The pattern of melt-rich versus mush regions along the transition segment and VFR mirrors the pattern seen along the southern EPR (Singh et al, 1998) and the Juan de Fuca ridge (Canales et al, 2006). About 90% of the axial magma lens corresponds to a crystal-laden sill, while the melt rich regions are typically 1-2 km long zones spaced at roughly 10 km intervals. In addition, there appears to be a tendency for melt-rich regions to correspond to areas of enhanced hydrothermal activity.

The estimated reflection coefficients for the VFR show elevated values over the interval between ~22° 23' S & 22° 30' S analyzed by *Collier & Sinha* (1992). This interval includes the high values associated with melt-rich region & the Misiteli field. Outside of this region, estimated reflection coefficients drop back down to levels closer to the those along the transition segment and estimated for the East Pacific Rise, ~0.2. Moreover, maximum coefficients are similar in the two segments, although the VFR estimates show more scatter, presumably due to the rougher topography. Thus it appears that the section of the VFR ridge studied by *Collier & Sinha* was somewhat anomalous and that any large-scale trends associated with the changing petrology or additional exsolved volatiles in the magma chamber are relatively muted.

References

- Baker, E.T., Resing, J.A., Walker, S., Martinez, F., Taylor, B., Nakamura, K., 2006. Abundant hydrothermal venting along melt-rich and melt-free ridge segments in the Lau back-arc basin, *Geophys. Res. Lett.* **33**, doi:10.1029/2005GL025283.
- Canales, J.P., Singh, S.C., Detrick, R.S., Carbotte, S.M., Harding, A., Kent, G.M., Diebold, J.B., Babcock, J., Nedimovic, M.R., 2006. Seismic evidence for variations in axial magma chamber properties along the southern Juan de Fuca Ridge, *Earth Planet. Sci. Lett.* **246**, 353-366.
- Collier, J.S., Sinha, M.C., 1992. Seismic Mapping of a Magma Chamber beneath the Valu Fa Ridge, Lau Basin, *J. Geophys. Res.* **97**, 14031-14053.
- Kaufman, L., Rousseeuw, P.J., 1990. Finding groups in data: an introduction to cluster analysis, Wiley, New York.
- Jacobs, A.M., Harding, A.J., Kent, G.M., 2007. Axial crustal structure of the Lau back- arc basin from velocity modeling of multichannel seismic data, *Earth Planet. Sci. Lett.* **259**, 239-255.
- Singh, S.C., Kent, G.M., Collier, J.S., Harding, A.J., Orcutt, J.A., 1998. Melt to mush variations in crustal magma properties along the ridge crest at the southern East Pacific Rise, *Nature*, **394**, 874-878.
- Vera, E.E., Mutter, J.C., Buhl, P., Orcutt, J.A., Harding, A.J., Kappus, M.E., Detrick, R.S., Brocher, T.M., 1990. The structure of 0-My to 0.2-My old oceanic-crust at 9°N on the East Pacific Rise from expanded spread profiles, *J. Geophys. Res.* **95**, 15529-15556.

Michael A.H. Hedlin

Research Geophysicist

Email address: hedlin@ucsd.edu

Phone extension: 48773

Research Interests: Analysis of acoustic signals from large-scale atmospheric phenomena; use of seismic and acoustic energy for nuclear test-ban verification.

Infrasound: The study of subaudible sound, or infrasound, has emerged as a new frontier in geophysics and acoustics. We have known of infrasound since 1883 with the eruption of Krakatoa, as signals from that event registered on barometers around the globe. Initially a scientific curiosity, the field briefly rose to prominence during the 1950's and 1960's during the age of atmospheric nuclear testing. With the recent Comprehensive Test-Ban Treaty, which bans nuclear tests of all yields in all environments, we have seen renewed interest in infrasound. A worldwide network of infrasound arrays, being constructed ostensibly for nuclear monitoring, is fueling basic research into man-made and natural sources of infrasound, how sound propagates through our dynamic atmosphere and how best to detect infrasonic signals amid noise due to atmospheric circulation.

Research at L2A: The new Laboratory for Atmospheric Acoustics (L2A) is the home of research in this field at IGPP. Several faculty, post-docs and PhD students work full or part time in L2A, supported by engineers and technicians in the lab and the field. Presently we study a broad suite of problems related to both natural and man-made sources.

Volcano acoustics: We believe that to properly characterize activity within volcanoes it is necessary to study the entire wavefield – that is downgoing seismic and upgoing acoustic energy. We anticipate that infrasound will also emerge in the next few years as an important tool for closely monitoring volcanoes for ash releases that might threaten aircraft and might not be detected on other monitoring systems, such as seismic networks and satellites. Following the recent eruptive activity at Mount Saint Helens (MSH), our group joined forces with the Geological Survey of Canada to deploy two infrasound arrays near this volcano. One was located on the northern flank of MSH. The other was positioned ~ 240 km to the east to detect stratospherically ducted infrasound waves. We study faint recurring long-period infrasound signals (Figure 1) that sometimes occur before large eruptions. We believe these signals will shed light on the internal workings of this volcano. We are also studying large eruptions, including one event in which ash was released to above 30,000 feet. This event was aseismic but was very prominent acoustically.

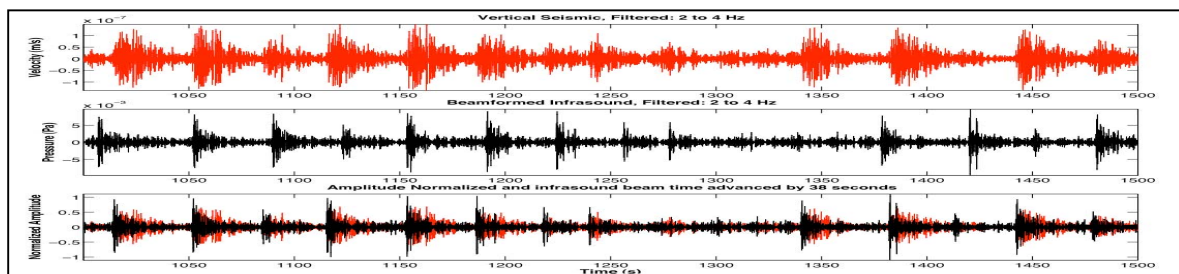

Figure 1: Seismic and infrasound signals from Mt St Helens are shown in the upper two traces. The two records are plotted together (bottom) after advancing the infrasound record 38 seconds to account for the propagation delay. The infrasound and seismic signals clearly have a common source within the volcano

Rocket experiments: Controlled sources (i.e. well known in terms of yield, 3-D location and time) can be used to study the propagation of infrasound through our turbulent atmosphere. Over the past few years we have collaborated with a number of other institutions across the United States to detonate 50-pound charges of high explosives at altitudes ranging up to 50 km. Such small charges detonated at high altitudes disturb a large volume of air, due to low confining pressure, and generate infrasound waves. We are presently modeling recordings of these explosions to improve our ability to locate infrasonic sources, and to study atmospheric structure.

Miscellaneous studies: 1) Bolides: The global infrasound network will be used to collect statistics on large meteors entering our atmosphere. We believe that this direct measure of the influx of meteors will provide the raw data for developing statistics on the largest meteors – the ones that might devastate large regions on impact. This field is in its infancy as we are just building the global network. These impulsive events are also useful for studying atmospheric structure. We are currently analyzing signals from a large bolide that exploded above Oregon using infrasound recordings using arrays located within 2,000 km of the event and seismic stations in the USArray seismic network. **2) Ocean noise:** Using data from our permanent array in the Anza-Borrego desert and two more arrays near San Diego we detect surf noise from along the coast of California. Infrasonic waves from the crashing surf propagate through the stratosphere to our stations up to 200 km away. We see further avenues for research in this area in that lower frequency signals, known as microbaroms, are known to propagate 1000's of km and can be used to study ocean storms remotely, and can be used to probe atmospheric structure. **3) Mine Blasts:** Our group is studying infrasound and seismic signals from mine blasts in Russia and the US to learn more about the physics of these sources and how waveform data can be used to discriminate these events from earthquakes and nuclear tests.

Field operations: Our group has built two permanent infrasound arrays in the US and one in Africa. In recent years we have deployed infrasound arrays across the southwestern US to record signals from high-altitude explosions and natural phenomena. We currently operate a research array located near San Diego. A typical temporary array comprises 4 aneroid microbarometers spanning an area 100 meters across, with data recorded using 24-bit Reftek digitizers and telemetered in realtime to our lab in La Jolla. We use Sun workstations and a suite of Macintosh G4 and G5 computers. All data from the field is archived on a 1.3 TB RAID. All computers, and supporting peripherals such as printers, are linked via a broadband communications network.

Relevant Publications

Arrowsmith, S.J., Drob, D.P., Hedlin, M.A.H. and Edwards, W., 2006, A joint seismic and acoustic study of the Washington State bolide: Observations and modeling, in review with *Journal of Geophysical Research*. v112, D09304, doi:10.1029/2006JD008001.

Arrowsmith, S. & Hedlin, M.A.H., 2005, Observations of infrasound from surf in Southern California, *Geophysical Research Letters*, **32**, No. 9, L09810, doi:10.1029/2005GL022761.

Bass, H., Bhattacharyya, J., Garces, M., Hedlin, M.A.H., Olson, J. and Woodward, R., 2006, *Infrasound, Acoustics Today*, **2**, 9-19.

de Groot-Hedlin, C.D., Hedlin, M.A.H., Walker, K., Drob, D., and Zumberge, M., 2008, Study of propagation from the shuttle Atlantis using a large seismic network, *J. Acoust. Soc. Am.*, in press.

Hedlin, M.A.H. and Alcoverro, B., 2005, The use of impedance matching capillaries for reducing resonance in rosette spatial filters, *J. Acoust. Soc. Am.*, **117**, 1880-1888.

Hedlin, M.A.H., 2006, Infrasonic Monitoring, 2006 Yearbook of Science and Technology, McGraw-Hill, 163-166.

Matoza, R.S., Hedlin, M.A.H., Garces, M.A., 2006, An infrasound array study of Mount St Helens, *Journal of Volcanology and Geothermal Research*. v160, issues 3-4, p249-262.

Walker, K., Zumberge, M., Hedlin, M.A.H., and Shearer, P., .., 2007, Methodologies for determining infrasound phase velocity direction with an array of directional acoustic sensors, *J. Acoust. Soc. Am.*, in press.

Glenn Ierley

Professor

Email: grierley@ucsd.edu

Phone: 4-5917

Research interests: turbulence, applied mathematics

In the past year I have been working closely with Dr. Phil Livermore, who arrived at Scripps last August. Our first goal was to understand the nature of a particular constraint on the magnetic field in the conducting core of the Earth. This constraint, due to J. B. Taylor in 1963 states that, in the absence of viscosity (and suitably nondimensionalized, that of the Earth is perhaps as small as 10^{-15}), the net zonal Lorentz force on each “geostrophic contour” must vanish. A “geostrophic contour” is defined as a constant density surface at a given distance from the axis of rotation. For this purpose the Earth’s core is sufficiently uniform in density that such surfaces are cylindrical shells concentric with the rotation axis, complicated topologically by the presence of the solid inner core.

This homogeneous constraint assumes the form of an integral quadratic in the magnetic field, which must vanish at each cylindrical radius. What we have found is that given certain assumptions on the form in which the field is expressed, the desired vanishing of the integral can be enforced identically if a certain discrete set of algebraic equations is satisfied. Enumerating that set is elementary if an inner core is absent, and amounts to a modest restriction on the class of admissible magnetic fields. With the inner core, the counting becomes trickier. In the end there are roughly three times the number of constraints to enforce but this case also proves not very demanding on the magnetic field.

A richer constraint, whose implications we are just now beginning to explore, requires not only the above, which is a kinematic restriction, but a dynamical generalization, that the motions in the core be just such as to match the observed temporal evolution of the field at the core-mantle boundary, while preserving the Taylor condition. This is much harder to do, leading us to *inhomogeneous* cubic constraints, and many more of them. It remains to be seen what the quantitative consequences are for models of the present Earth’s field.

An unanticipated by-product of the exploration above was the serendipitous discovery of a new general class of orthogonal polynomials that allow in a natural way for the accommodation of boundary conditions. The term “Galerkin” is used for an expansion in basis functions each of which satisfies one or more homogeneous boundary conditions for a problem. As a rule, such basis functions are not mutually orthogonal and they may or may not be an “efficient” basis set in the sense that one obtains high accuracy with only a modest number of elements. By contrast, the class that we have discovered is easily generated by using certain standard stable recurrence relations, turns out to be mutually orthogonal no matter the number and order of boundary conditions imposed, and is assured of being an “efficient” set. A proof of these properties and a derivation of the algorithm for their construction is not easy however. Although we have succeeded in proving these properties for a variety of cases, a completely general proof is still lacking and perhaps is not even possible, although there can be no doubt the propositions are true in general. It is probably this degree of complication that accounts for no one having spotted this very general family before. But, technical proof aside, the *application* of these polynomials in practice is fortu-

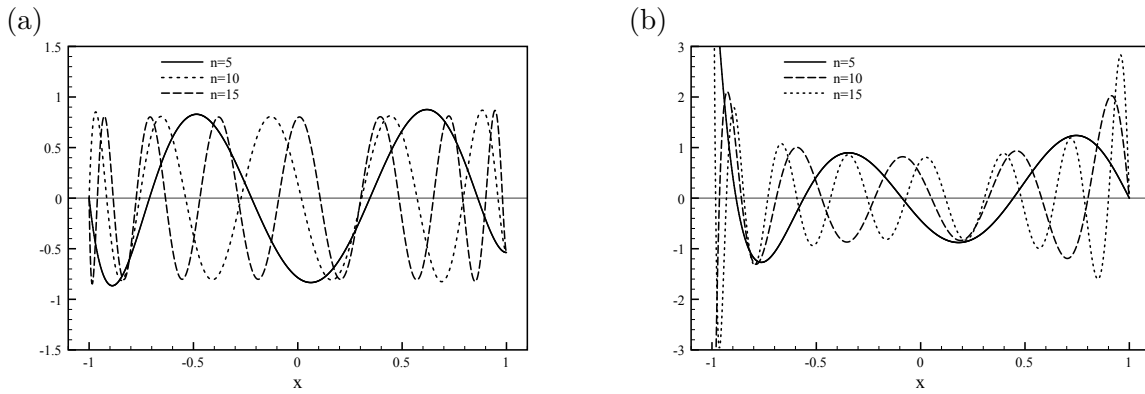

Figure 1: Plots of basis functions for $n = 5, 10, 15$. In (a), $\alpha = \beta = -1/2$ and the functions satisfy the two-sided boundary conditions $\Psi_n(-1) = \Psi_n(1) = 0$; in (b), $\alpha = \beta = 1/2$ and the functions satisfy the one-sided boundary condition $\Psi_n''(1) = \Psi_n(1) = 0$. Note the quasi-equal-area property of the functions in (b) and the quasi-equal-ripple property in (a).

nately elementary. Examples of these polynomials are indicated in Figure 1. The family is characterized by two parameters, conventionally α and β . Values of interest for these are normally $[-1/2, 0, 1/2]$ although any values greater than or equal to $-1/2$ are allowed.

Research Geophysicist

Email address: gkent@ucsd.edu, phone extension: 4-7386

Research Interests: marine seismology, extensional tectonics, paleoseismology/geohazards, mid-ocean ridge processes, immersive visualization, High Sierra climate

2008 Topic: New constraints on hydroclimatic change during the last 10,000 years in the High Sierra from geophysical measurements in Fallen Leaf Lake, Tahoe Basin, California

The Sierra Nevada is the primary source of California's and northwestern Nevada's water resources. To understand the potential for severe and prolonged drought in the Sierras, it is necessary to study past events recorded by proxy data. Fallen Leaf Lake (FLL), California, is a unique glaciolacustrine environment in which several climate proxies exist to provide potential records of hydroclimatic change during the last ~10,000 years. Recent studies have discovered submerged and upright trees rooted ~36 m below the surface of FLL, suggesting lake levels were significantly lower during the past. Several trees have been radiocarbon dated at ~1200 AD, which is consistent with the timing of the Medieval Climatic Anomaly (MCA) observed at other locations in the Sierra. Furthermore, several studies have presented evidence for lake-size fluctuations and a mid-Holocene dry period in the eastern Sierra, one of which (Pyramid Lake, Nevada) is within of the same watershed as FLL. We conducted field campaigns during 2006–2008 to collect high-resolution marine side-scan and seismic CHIRP imagery, sediment cores and ROV video footage in FLL to search for additional submerged trees, as well as geomorphic and sedimentary evidence for hydroclimatic changes. Sidescan sonar imagery provided complete coverage the lakefloor and successfully imaged as many as 9 upright trees, over 80 downed trees, and what appear to be many in-situ stumps. Sidescan and ROV data also show multiple submerged paleoshorelines along the entire circumference of FLL to depths > ~60 m.

In addition, over 40 line-km of seismic CHIRP data and 5 piston cores were collected to define the depositional and earthquake histories along the West Tahoe-Dollar Point Fault (WTDPF), which passes through the southern part of FLL. Based on radiocarbon samples from cores, deposition of material with relatively high magnetic susceptibility occurred between 3.6 - 4.9 kyr BP, suggesting a change in depositional character during the mid-Holocene. CHIRP profiles have acoustic penetration over 50 m, providing a stratigraphic framework for the entire Holocene. We observe up to 50 m of lacus-



Graham Kent (left) and Neal Driscoll collecting side-scan sonar and seismic CHIRP imagery on another famous California lake—the Salton Sea.

trine sediments above a hummocky basal reflector, which is inferred to be coarse grained Tioga-aged glacial material. Stratal geometry observed in CHIRP profiles shows a combination of current controlled (contourite drifts) and gravity driven deposition in the upper 20-30 m. Below this, deposition appears more uniform, implying a change occurred in the hydrodynamic conditions and/or sediment flux during the early to mid-Holocene. Based on the lakefloor morphology and timing of the most recent earthquake on the WTDPF (4.1 - 4.5 kyr BP), the submerged, upright trees appear to have been preserved in-situ. In summary, the data suggest dramatic changes in the shoreline and sedimentary processes have occurred during the Holocene and demonstrate: (1) the feasibility of high-resolution geophysical methods towards finding paleoclimate proxies, and (2) the potential for the most complete, and highest fidelity paleoclimate record within the High Sierra at Fallen Leaf Lake.

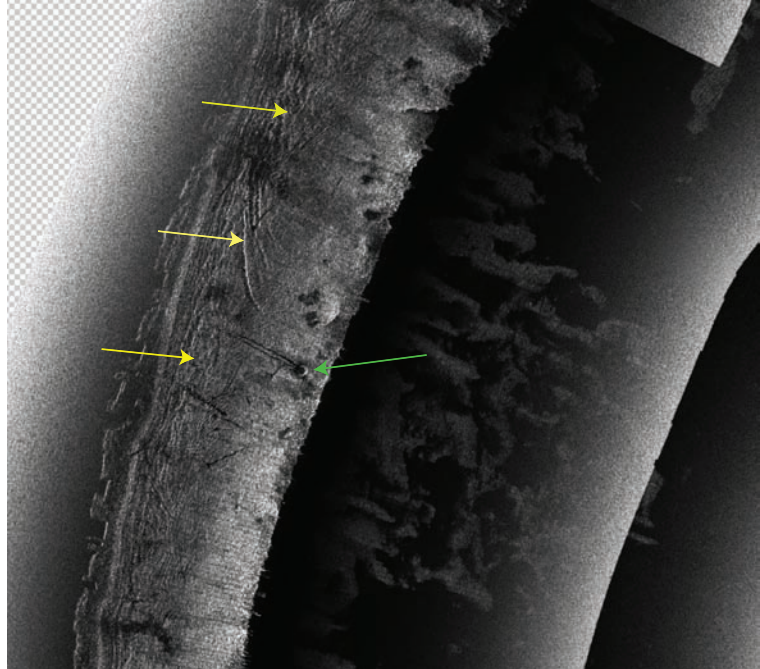

Side-scan sonar data from Fallen Leaf Lake (Tahoe basin), highlighting paleoshorelines (yellow arrows), and one of the many upright, submerged trees (green arrow) that casts a shadow (10 o'clock). This shadow is from a submerged pine tree with a bifurcated trunk that appears as two separate “drop outs” in the side-scan data! Many other trees and trunks are also visible in this image.

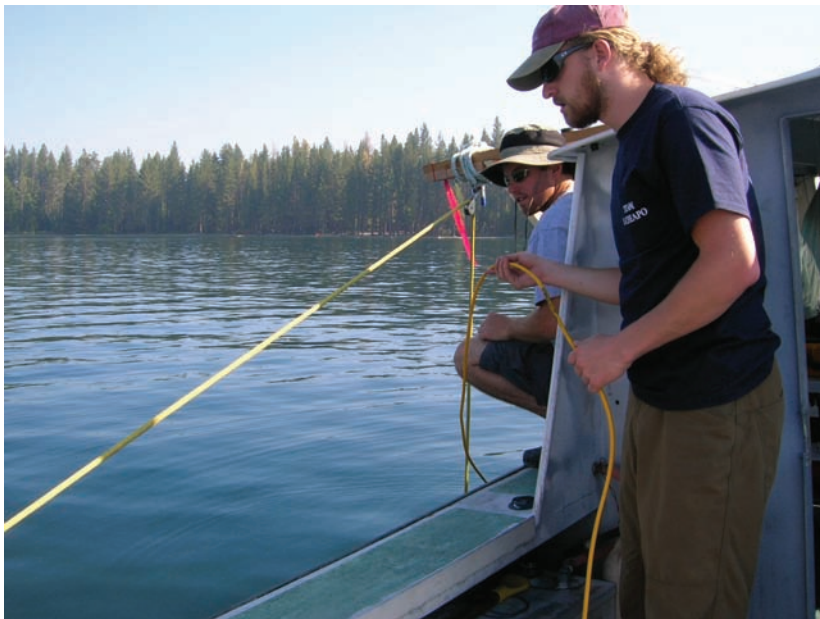

Graduate student Danny Brothers (left) and undergraduate summer intern Stefan Jensen (Northwestern University) deploy the side-scan sonar into the cobalt waters of Fallen Leaf Lake.

Deborah Lyman Kilb

Associate Project Scientist

Email address: dkilb@ucsd.edu

Phone extension: 2-4607

Research Interests: Crustal seismology, earthquake triggering, earthquake source physics.

Deborah Kilb's current research areas include crustal seismology and earthquake source physics, with an emphasis on understanding how one earthquake can influence another.

Ability for Large Earthquakes to Trigger Mud Volcano Eruptions: In collaboration with Dr. Mellors (SDSU), and his coworkers, Kilb investigates the ability for large earthquakes to trigger mud volcano eruptions (Figure 1). They find the temporal correlation between earthquakes and eruptions is most pronounced for nearby earthquakes (within ~100 km) that produce seismic intensities of Mercalli 6 or greater at the location of the mud volcano (Mellors *et al.*, 2007).

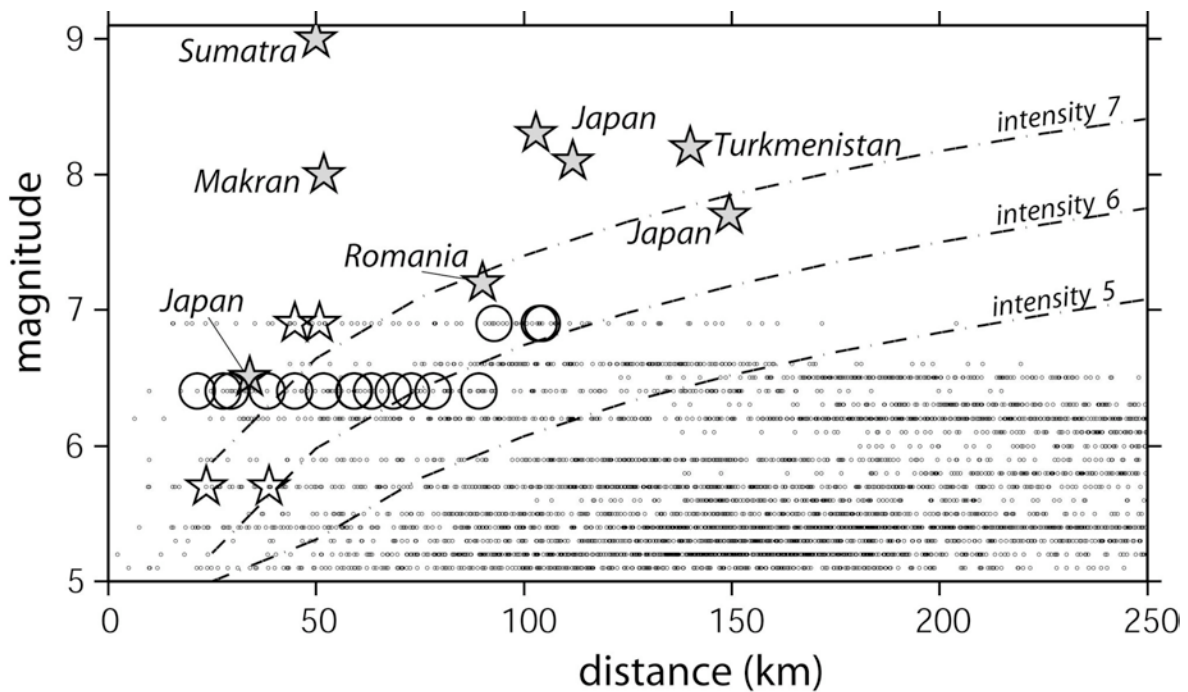

Figure 1. Plot of distance versus magnitude for earthquake and mud volcano pairs. Small dots show non-triggering distance/magnitude pairs in our catalog (from each earthquake epicenter to a known mud volcano location that did not erupt). Open stars show Azerbaijan mud volcano locations that were reported to have eruptions on the same day as a large earthquake. Open circles indicate where there was reported increased volcanic activity after large earthquakes in November/December 2000. Gray stars show magnitude/distance for other reported earthquake/eruption triggering pairs. Approximate Mercalli earthquake intensity bounds (dashed lines) are also shown. Note that seismic shaking of approximately Mercalli intensity 6 represents an approximate lower limit for triggering and that open stars juxtapose with small dots indicating that the assumed distance/magnitude triggering thresholds are sufficient but not always imperative, suggesting mud volcano's require a recharging time to re-accumulate pressure.

Quantifying the Remote Triggering Capabilities of Large Teleseismic Earthquakes: Kilb and graduate student Deborah Kane are establishing new techniques to quantify the remote triggering capabilities of large teleseismic earthquakes. They search the ANZA network catalog for evidence of remote triggering, using three statistical tests (Binomial, Wilcoxon Rank-sum, and Kolmogorov-Smirnov) to determine the significance of quantity and timing of earthquakes in southern California before and after large teleseismic events. They find minimal differences between the spectral amplitudes and maximum ground velocities of the local triggering and non-triggering earthquakes. Similar analysis of remote earthquakes shows that the related ground motion regularly exceeds that of local earthquakes, both at low frequencies and in maximum velocity. This evidence weakly suggests that triggering requires larger amplitudes at high frequencies and that a maximum ground velocity alone is not the primary factor in remote triggering. Our results are complex, suggesting that a triggering threshold, if it exists, may depend on several factors. (Kane *et al.*, 2007).

The Temporal Lag Between a Mainshock and the First Aftershocks: Aftershocks are often obscured by the large decaying amplitude of the mainshock's seismic waves (coda), making it difficult to identify early aftershocks. Working with IGPP's Drs. Vernon and Martynov, Kilb examined the temporal lag between the mainshock and the first aftershocks in the Anza 2001, southern California, sequence. The results show that the size of the magnitude differential between a mainshock and its largest aftershock is likely dictated by a combination of factors that include the complexity of the fault system and the propensity for relatively large earthquakes to occur in the region (Kilb *et al.*, 2007).

Seismogenic, Electrically Conductive, and Fluid Zones at Plate Boundaries: Working with Dr. George Jiracek (SDSU) and his-coworkers, Kilb examines the seismogenic, electrically conductive, and fluid zones at plate boundaries in New Zealand, Himalaya, and California. The results indicate that there is increasing evidence that processes removed from the actual seismogenic zone, such as the occurrence of trapped fluidized zones in the ductile crust, may be very important in the earthquake nucleation process (Jiracek *et al.*, in press 2007).

See <http://eqinfo.ucsd.edu/~dkilb/current.html> for an expanded description of these research projects.

Relevant Publications

Kane, D.L., D. Kilb, A. S. Berg & V. G. Martynov, "Quantifying the Remote Triggering Capabilities of Large Earthquakes Using Data From The ANZA Seismic Network Catalog (Southern California)", *J. Geophys. Res.*, 112, B11302, doi:10.1029/2006JB004714, 2007.

Kilb, D., V. G. Martynov, & F. L. Vernon, "Aftershock Detection Thresholds as a Function of Time: Results from the ANZA Seismic Network following the 31 October 2001 *ML* 5.1 Anza, California, Earthquake," *Bull. Seism. Soc. Am.*, 97780–97792, doi: 10.1785/0120060116, 2007.

Jiracek, G.R., V. M. Gonzalez, T. G. Caldwell, P. E. Wannamaker, & D. Kilb, "Seismogenic, Electrically Conductive, and Fluid Zones at Continental Plate Boundaries in New Zealand, Himalaya, and California-USA", *AGU Geodynamics Monograph Series* 175, AGU., Washington, DC, 347-369, 2007.

Mellors, R., D. Kilb, A. Aliyev, A. Gasanov, & G. Yetirmishli, "Correlations Between Earthquakes and Large Mud Volcano Eruptions," *J. Geophys. Res.*, 112, B04304, doi:10.1029/2006JB004489, 2007.

Gabi Laske
Associate Research Geophysicist
Email: glaske@ucsd.edu
Phone: 4-8774

Research interests: seismic surface waves and global seismology; regional seismology; seismic recordings on the ocean floor; ocean noise; natural disasters and global change

Gabi Laske's main research area is the analysis of free oscillations and seismic surface waves and the assembly of global and regional models.

Free oscillations, global and regional tomography: Free oscillation parameters provide invaluable constraints on Earth's internal structure that remain elusive to other seismic techniques. The great 2004 Sumatra–Andaman earthquake and many more recent events allow the measurement of these parameters to unprecedented precision. Laske and colleagues continue to refine the free oscillation database that will define the new REM (Reference Earth Model). Laske's global surface wave database has provided key upper mantle information in the quest to define whole mantle structure. Graduate student Christine Houser recently used her data to compile an improved model of mantle shear and compressional velocity and bulk sound speed.

Laske has been involved in the DESERT project (Dead Sea Rift Transect) to image crustal and mantle structure beneath the Araba Valley south of the Dead Sea. An intriguing aspect of this research is to find the cause for the uplift of the Arabian Plateau east of the Dead Sea Transform Fault. Thermo-mechanical modeling suggests that a plume responsible for the Red Sea rifting could have eroded the Arabian lithosphere though Laske's surface wave study does not appear to support this idea. All other seismic component of this project were either equivocal or inadequate to address this issue.

The PLUME project: Laske is the lead-PI of the multi-institutional, multi-disciplinary Hawaiian **PLUME** project (Plume–Lithosphere–Undersea–Melt Experiment) to study the plumbing system of the Hawaiian hotspot (Figure 1). The project aims to address fundamental issues such as the geographical location of the plume head and conduit and whether or not the plume originates in the lower mantle. Before PLUME, little was known about the seismic structure beneath Hawaii due mainly to the fact that the nearly linear alignment of the Hawaiian islands does not allow seismologists to obtain complete and unbiased images. The PLUME project is driven by seismology and includes co-PIs from SIO (Laske, Orcutt), WHOI (Collins, Detrick), U. Hawaii (Wolfe), DTM (Solomon, Hauri) and Yale Univ. (Bercovici). The centerpiece of the project is a large broad-band OBS array which is augmented by a 10-station land array. Occupying a total of over 80 sites and having an aperture of over 1000km, this experiment is one of the largest in the world. It is one of the first large-scale, long-term broad-band OSB deployments.

An initial 35-station array deployed in 2005 with small station spacing and aperture focussed on the island of Hawaii, where the plume head is assumed to be located. A second, wider 38-instrument array deployed in 2006 reached into the lower mantle and gathered off-swell reference data for the undisturbed Pacific Ocean. With instrument recovery rates of 91% and 79% the deployment phase was highly successful, especially considering that more than half the instruments were never deployed before. Both deployments collected nearly 200 earthquakes each, providing excellent azimuthal coverage. The surface wave analysis of the first deployment reveals a roughly 30km thick low-velocity anomaly in the lower lithosphere beneath the islands of Hawaii and Maui that may be manifest of the

Figure 1: Deployment plan of the two-stage PLUME experiment. Also shown are existing and planned permanent stations of the global seismic network. The SWELL pilot array collected data on differential pressure sensors between April 1997 and May 1998.

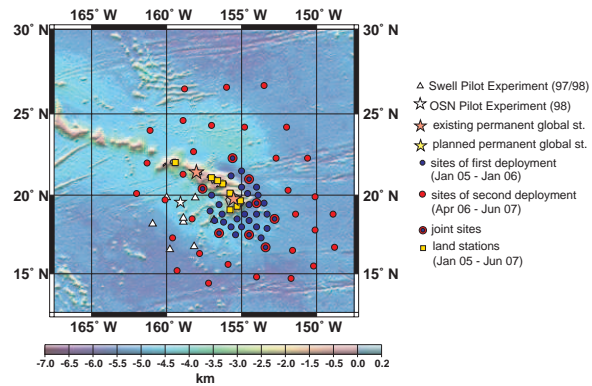
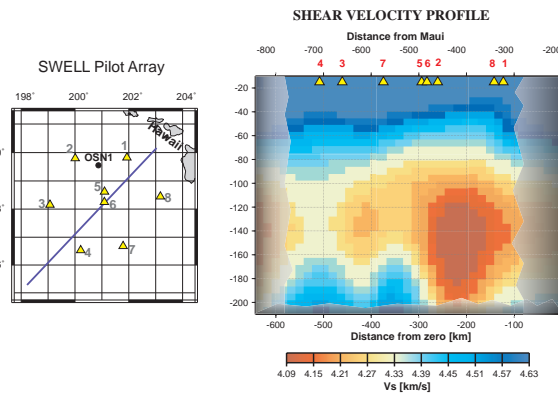

Figure 2: Cross section of the 3-D shear velocity model from the SWELL pilot experiment. Velocities represent averages over a 100 km wide corridor along the profile. Imaging capabilities are reduced toward the ends of the profile because of lack of data (e.g. the apparent thickening of the lithosphere east of sites #1 and #8). A rejuvenation of the lithosphere toward the island chain is clearly imaged. "Distance from zero" refers to the distance from the northeastern end of the line marked in the map.



assumed plume head. Deeper imaged features suggest that the proposed plume conduit is not located to the southeast but to the west of Hawaii. These results are consistent with Laske's earlier findings from the 97/98 SWELL pilot experiment that covered an area in the southwestern corner of PLUME. SWELL showed conclusively that the Hawaiian lithosphere has undergone a rejuvenation process though the idea of mechanical erosion appears inconsistent with the data (Figure 2).

Recent publications:

- Houser, C., Masters, G., Shearer, P. and Laske, G., Shear and compressional velocity models of the mantle from cluster analysis of long-period waveforms, *Geophysical Journal International*, 174, 195-212, 2008.
- Laske, G., Weber, M. and the DESERT Working Group. Lithosphere Structure Across the Dead Sea Transform as Constrained by Rayleigh Waves Observed During the DESERT Experiment, *Geophys. J. Int.*, 173, 593-610, 2008.
- Laske, G. and Widmer-Schmidrig, R., Normal Modes & Surface Wave Measurements, *Treatise of Geophysics*, vol.1, Seismology and Structure of the Earth, Ed. B. Romanowicz and A.M. Dziewonski, 67-125, 2007.
- Laske, G., The Hawaiian SWELL Pilot Experiment – Evidence for Lithosphere Rejuvenation from Ocean Bottom Surface Wave Data, *GSA Special Paper 430*, doi: 10.1130/2007.2430(11), 2007.

Guy Masters
Professor of Geophysics
Email: gmasters@ucsd.edu
Phone: 44122

Research interests: Global seismic tomography using free oscillations, surface waves and body waves; interfacing seismology and mineral physics.

In 2008, Guy Masters has continued to focus on improving global 3D models of the Earth using seismic tomography. We have paid particular emphasis to developing fast interactive techniques for measuring arrival times of long-period body waves using a cross-correlation/cluster analysis technique. The technique is described in Houser et al (2008a) along with new 3D whole-mantle models of P and S velocity built from our greatly enhanced data sets. Graduate student Urska Manners has adapted the technique to measure large data sets of travel times of core-diffracted waves to elucidate the nature and structure of the D" (core-mantle boundary) region. The addition of diffracted phases greatly improves sampling, particularly in the southern hemisphere and has allowed us to better define the "superplume" structures in the deep mantle. These new data sets have been jointly inverted with existing data sets to give improved models of deep mantle structure using both ray theory and finite frequency kernels (Manners and Masters, 2008a, Manners et al, 2008).

One of the more intriguing aspects of these models is the anticorrelation of bulk sound speed anomalies to shear velocity anomalies seen in the superplume structures beneath Africa and the central Pacific. Almost all models show this feature in the D" region but there is little agreement on how high above the CMB (core-mantle boundary) it extends. It is important to nail this down since, if the anticorrelation is confined to the lowermost mantle, it could be related to the recently discovered post-perovskite phase transformation. However, if it extends significantly above the CMB, we must invoke compositional variations to explain the signal. We have found that the variability among current bulk-sound speed models is largely explained by differences in how various researchers handle the signal from earthquake mislocation. This aspect is studied in Manners and Masters (2008c) where we determine which methods can give unbiased answers. Our best models now have the anticorrelation extending several hundred kilometers and the CMB, suggesting this must be a chemical effect rather than a result of the phase transformation. Finally, we note that Manners and Masters (2008b) introduce a novel technique to construct bulk-sound speed travel time residuals directly from S and P travel time residuals for the same source-receiver pairs. These bulk sound speed residuals also imply that the anticorrelation of bulk sound speed and shear velocity extends well above the CMB.

During the last year, Masters has extended the cross-correlation/cluster analysis technique to work with surface wave envelope functions – essentially measuring relative group arrival times. The technique has allowed us to measure 300,000 relative arrival times for Rayleigh waves for each of several frequencies spanning 7.5MHz to 35MHz. The data can be very accurately represented by a group velocity map for each frequency which can reproduce the group arrival times very accurately. Fig 1. shows group velocity maps for a variety of frequencies. At the highest frequencies (top of Figure 1), the signal is primarily due to variations in crustal thickness and such maps can be used to improve our global crust and lithosphere models. A preliminary inversion reveals that our current global crustal model (CRUST 2.0) has many deficiencies and we can anticipate much better models in the near future.

Recent Publications

Houser, C., G. Masters, P. Shearer, and G. Laske., Shear and compressional models of the mantle from cluster analysis of long-period waveforms, *Geophys. J. Int.*, 174, doi: 10.1111/j.1365-246X.2008.03763.x, 2008a.
Houser, C., G. Masters, M. Flanagan, and P. Shearer, Determination and analysis of long-wavelength transition zone structure using SS precursors, *Geophys. J. Int.*, 174, doi: 10.1111/j.1365-246X.2008.03879.x, 2008b.
Gubbins, D., G. Masters and F. Nimmo, A thermochemical boundary layer at the base of Earth's outer core

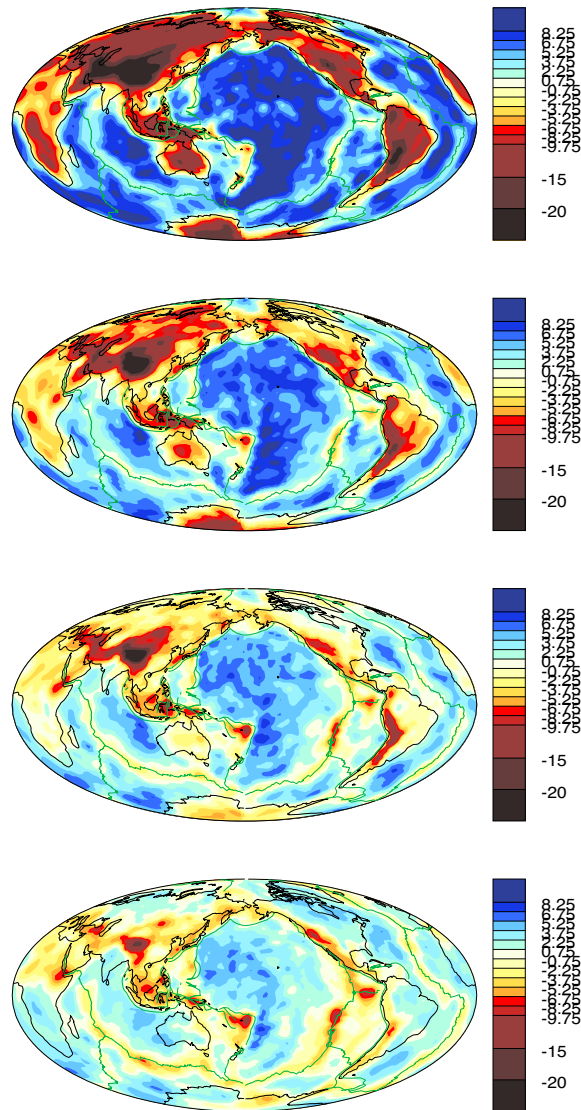

Figure 1: Group velocity maps for Rayleigh waves (perturbations in percent) at four different frequencies: from bottom to top, 15mHz, 20mHz, 25mHz, and 30mHz. At the lowest frequencies, slow anomalies can be identified in oceanic regions which disappear at higher frequencies but the most obvious features are associated with thick continental crust (Himalayas and Andes) and get extremely large in amplitude at short periods.

and independent estimate of core heat flux, *Geophys. J. Int.*, 174, doi: 10.1111/j.1365-246X.2008.03719.x, 2008.

Manners, U., and G. Masters, Analysis of core-mantle boundary structure using S and P diffracted waves, *Geophys. J. Int.*, , submitted, 2008a.

Manners, U., Q. Liu, G. Masters, and J. Tromp, Modeling the lowermost mantle using diffracted phases and finite frequency kernels, *Geophys. J. Int.*, , submitted, 2008.

Manners, U., and G. Masters, Relations between shear velocity and bulk sound speed in the lower mantle, *Geophys. J. Int.*, , submitted, 2008b.

Manners, U., and G. Masters, A comparison of methods for global teleseismic earthquake relocation, *Bull. Seism. Soc. Am.*, , submitted, 2008c.

Jean-Bernard Minster

Professor of Geophysics

Email address: jbminster@ucsd.edu

Phone extension: 45650

Research Interests: Plate tectonics and plate deformation; Application of space-geodetic techniques to study crustal dynamics; Satellite laser altimetry and Satellite Synthetic Aperture Radar applications to Earth studies; Earthquake source physics and large-scale supercomputer earthquake simulations; Earthquake prediction, pattern recognition; Multiscale modeling in geophysics & applications of IT technologies to earthquake modeling; Verification of nuclear Test Ban Treaties by geophysical means, seismic, imaging, ionosphere. Application of hyperspectral imaging to paleoseismology. Member of the ICESat science team since 1989.

Hyperspectral images of paleoseismic trenches allow new approaches to extract paleoearthquake information from the geological record. *Field Imaging Spectroscopy*, as applied by Graduate Student Daniel Ragona, is a new methodology for data acquisition in the field using portable scanners. Analysis of such hyperspectral data in paleoseismology shows that high spatial and spectral resolution in the visible to short wave infrared provide a way to enhance subtle or even invisible stratigraphic and structural features. The use of neural networks and naïve Bayesian classifiers to automatically classify hyperspectral image data, yields an objective mapping of the structure of cores, samples and field exposures. In this way, a system that integrates a hyperspectral scanner with pattern recognition algorithms can work as an enhanced eye and an objective classifier. This provides the geologist with additional information to facilitate the final description, interpretation and correlation of the geology in paleoseismic exposures and cores. Coupled with a spectral library of the materials observed in the excavation this approach also offers a new way to archive paleoseismological data for future analysis.

Given the scarcity of near-source recordings for large earthquakes, numerical simulations play an important roll in the prediction of possible ground motion from future events. Simulations also give insight to physical processes of fault rupture that are difficult or impossible to empirically measure. Graduate Student Geoffrey Ely developed a novel finite difference simulation capability based on *Support Operators*. The implementation is highly scalable, enabling large scale, multi-processor modeling of earthquake rupture and wave propagation in realistic three-dimensional earth models with nonplanar interfaces and nonplanar ruptures. The method is used to simulate large (Mw7.6) earthquake scenarios along the southern San Andreas fault. The overall distribution of simulated peak ground velocities is consistent with those derived from the current empirical models, but important deviations associated with basin wave-guide and directivity effects have important consequences in terms of seismic hazard assessment (Figure 1). These simulations--which have been dubbed *TeraShake* simulations--have now been performed on a variety of computing platforms which involve hundreds to tens of thousands processors. This work is highly collaborative, involving scientists of the Southern California Earthquake Center in many Earth Science and Information Science disciplines.

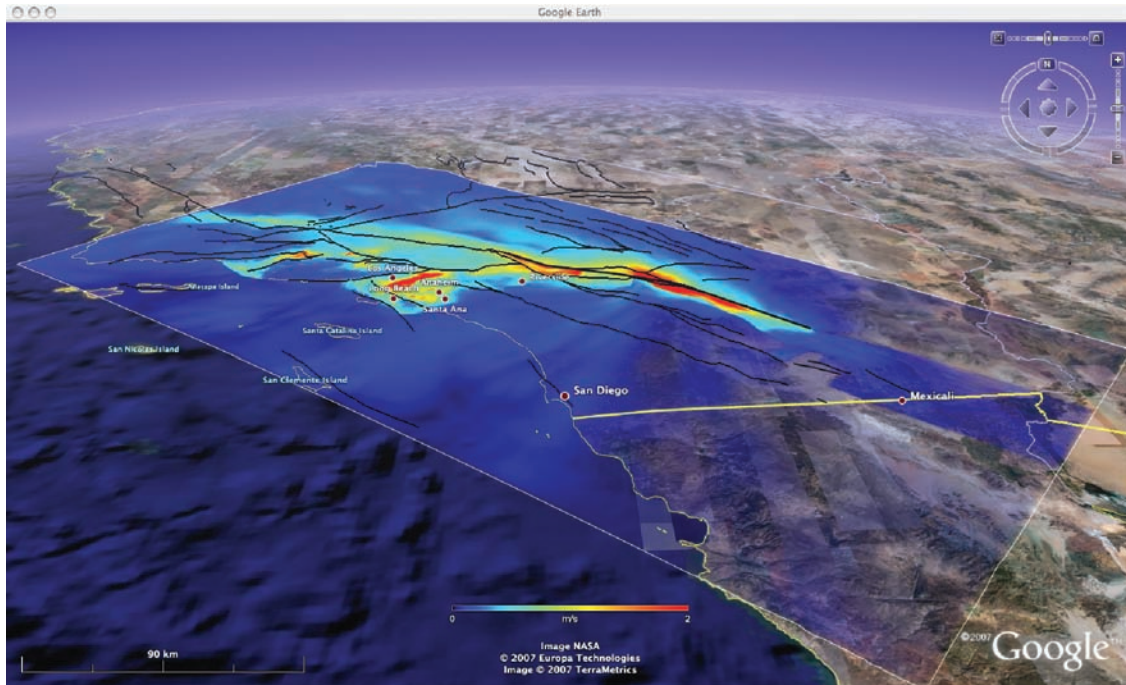

Figure 1: Distribution of peak ground velocities calculated from a supercomputer simulation of a magnitude 7.7 earthquake on the Southern San Andreas fault. Note the high level of shaking predicted in sedimentary basins of the Los Angeles area.

The salar de Uyuni in the Bolivian Altiplano is the largest salt flat on Earth, a surface whose size and almost complete absence of topography make it an ideal reference target for satellite-based altimeters. Graduate Student Adrian Borsa modeled that surface using a detailed kinematic GPS survey of the salar collected by a team of investigators in support of the ICESat satellite laser altimetry mission. This revealed decimeter-amplitude topography on scales of 5~50 km across the salar. The salt topography closely follows an equipotential surface of Earth's gravity field. Solution transport of salt by surface and subsurface water is a likely mechanism for this correlation.

Relevant Publications

- Ragona, Daniel, Bernard Minster, Thomas Rockwell, and Jouni Jussila, Field imaging spectroscopy: A new methodology to assist the description, interpretation, and archiving of paleoseismological information from faulted exposures, *J. Geophys. Res.*, **111**, B10309-2006, doi:10.1029/2006JB004267, 2006.
- Ely, Geoffrey P. Steve M. Day and Jean-Bernard Minster, A support-operator method for viscoelastic wave modeling in 3-D heterogeneous media, *Geophys. J. Int.*, doi:10.1111/j.1365-246X.2007.03633.x, 2007.
- Borsa, Adrian, Bruce G. Bills, and Jean-Bernard Minster, Modeling the topography of the salar de Uyuni, Bolivia, as an equipotential surface of Earth's gravity field, *J. Geophys. Res.*, In Press, 2008.
- Olsen, K. B., S. M. Day, J. B. Minster, Y. Cui, A. Chourasia, D. Okaya, P. Maechling, and T. Jordan, TeraShake2: Simulation of Mw7.7 earthquakes on the southern San Andreas fault with spontaneous rupture description, *Bull. Seism. Soc. Am.*, **98**, doi:10.1785/0120070148, pp. 1162-1185, 2008.

Walter Munk**Research Professor**

Email address: wmunk@ucsd.edu

Phone extension: 42877

Research Interests: Ocean Acoustics and Physical Oceanography.

AN INCONVENIENT SEA-TRUTH: Spread, Steepness and Skewness of Surface Slopes. In press in Volume 1, No 1 of Annual Reviews on Marine Science.

I have worked on waves in the 1 mm to 1 m scales, straddling the transition from gravity to surface tension. These scales have received very little attention as compared to the longer surface waves, yet these are the scales at which momentum is transferred from atmosphere to ocean (wind stress). The incentive for this study came from a recent French compilation of 8 million satellite images of sun glitter. The compilation raises more questions than it answers, hence the title. Significant information concerning the short waves comes (surprisingly) from measurements of pressure on the deep-sea bottom (the microseism problem) reported separately in a short paper with William Farrell, a former IGPP student.

GLIMPSES OF OCEANOGRAPHY IN THE POSTWAR PERIOD, to be published by The Oceanographic Society in celebration of their 20th anniversary. The article reviews two recent books on the subject. My personal memories differ from the published accounts.

Relevant Publications

1. Munk, W. (2006) From Ocean Acoustics to Acoustic Oceanography. *EOS Transactions AGU 87: Ocean Sciences Meeting Supplement*, Abstract OS51A-02.
2. Munk, W. and D. Rudnick (2006) Penetrating the Deep Sound Channel; A Geometric Measure. *EOS Transactions AGU 87: Ocean Sciences Meeting Supplement*, Abstract OS52J-02.
3. Colosi, J.A., and W. Munk (2006) Tales of the Venerable Honolulu Tide Gauge. *J. Phys. Oceanogr.*, 36(6): 967-996.
4. Munk, W. and B. Bills (2007) Tides and the climate; some speculations. *J. Phys. Ocean.*, 37(2): 135-147.
5. Munk, W. (2008) An Inconvenient Sea-Truth: Spread, Steepness and Skewness of Surface Slopes. *Annual Review of Marine Science*. in press.
6. Farrell, W.E. and W. Munk (2008) What Do Deep Sea Pressure Fluctuations Tell about Short Surface Waves? *Geophysical Research Letters*, in press.
7. Munk, W. and D. Day (2008) Glimpses of Oceanography in the Postwar Period. *Oceanography*, in press.

John A. Orcutt

Distinguished Professor of Geophysics

Email address: jorcutt@ucsd.edu

Phone Extension: 42887 IGPP; 26378 California Institute for Telecommunications & Information Technology (Calit2)

OBSIP - Jeff Babcock and I operate the Scripps' Institutional Instrument Center for the NSF Ocean Bottom Seismograph Instrument Pool (OBSIP; <http://obsip.ucsd.edu>). The other major facility is at Woods Hole and Lamont Doherty Earth Observatory re-joined the OBSIP in 2007. The purpose is to serve the entire US marine seismology community by providing instrumentation and expertise in collecting marine seismic data through the standard NSF proposal process. In addition, we have built substantial numbers of identical instruments to initiate similar programs in the United Kingdom (National Oceanography Centre, Southampton), France (Institut de physique du globe de Paris [IPGP]) and Spain (Unidad Tecnologia Marina [UTM]). The instrumentation available globally is extensive.

The current fleet comprises approximately 69 short period units and 41 long period (or broadband) instruments. The broadband units make use of new 250s natural period Nanometrics accelerometers for recording low frequency and broadband data. These instruments have been used recently in the Hawaii Plume experiment (see the Laske article in this report) as well as several others. During the Plume experiment Laske observed normal modes including OS6 ($\approx 1.04\text{mHz}$) and others that were unobservable on many island stations. This was the first time such observations at very low frequencies have been observed by seafloor seismographs.

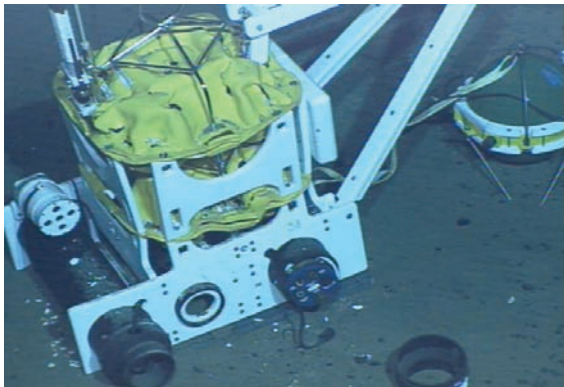

Figure 1: Catastrophic failure of broadband OBS at $\approx 6\text{km}$ depth.

During a summer 2007 recovery cruise at the Plume site, several Scripps and Woods Hole instruments were not recovered. In order to understand the failure modes, an expedition with Woods Hole's Remotely Operated Vehicle (ROV) Jason was scheduled in October. Figure 1 shows one of the Scripps' instruments in about 6 km of water. The glass balls used for floatation imploded and the "hard hats" surrounding the missing balls are crumpled. The implosion of the floats buckled the aluminum instrumentation pressure cases

and, in this case, blew out the end caps and parts are strewn around the seafloor. The implosions did not always occur at the landing time, but in some cases months later implying an aging process in the glass that inevitably leads to failure under high pressure. As the numbers of seafloor instruments and the length of deployments have increased markedly, we find new failure modes, which require changes in engineering, construction and operations.

Cyberinfrastructure – HiSeasNet (<http://hiseasnet.ucsd.edu>) is a satellite communications network operated by Jon Berger and myself at IGPP, which is designed to provide continuous Internet connectivity for oceanographic research ships and platforms. Access to the Internet is an integral part of nearly every research lab and office on land; extending this access to oceanographic ships – our seagoing laboratories – broadly impacts seagoing research activities. Scientists have been going to sea in ships now for approximately 250 years. While the nature of ships has changed during that period of time making oceanographic research at sea increasingly productive, future changes in ship design will have only incremental impacts on the field. On the other hand, tools including the use of the global positioning system (GPS) with accuracies at sea now on the order of one meter or even better and the extension of the Internet to sea are highly *disruptive* technologies

that change the way oceanography is conducted. In May, Scripps added the 15th ship in the US academic fleet to HiSeasNet comprising all the largest ships as well as the intermediate ships. The system relies upon C-Band and Ku-Band antennae located on the roof of UCSD's San Diego Supercomputer Center. Real-time position and photographs from the R/V Roger Revelle can be viewed at http://mercali.ucsd.edu/rtapps/rtimbank.php?camera=SIO_Revelle_Axis2.

The NSF Ocean Observatories Initiative (OOI) comprises three types of interconnected observatories spanning global, regional and coastal scales. I am the Project Director for the cyberinfrastructure (CI) component of the OOI and Frank Vernon serves as Deputy Project Director. Matt Arrott, at Calit2, is the CI Program Manager. The functional scope of the cyberinfrastructure architecture is unusual and extensive:

- Interactive Ocean Observing
- Interactive Ocean Modeling & Data Assimilation
- Computer-controlled Automated Data Product Generation
- Discipline-Driven Semantic Organization of Data
- Interactive Instrument Network
- Integrated Observatory Management
- User-Controlled Integration of Resources

The data are available in near-real-time (latencies of seconds) and to anyone interested in the data streams. The data streams are continuous and pushed to the users placing a premium on computing methods that are stream-based and not file-based as has been the case for decades. Figure 2 provides an overall view of the cyberinfrastructure.

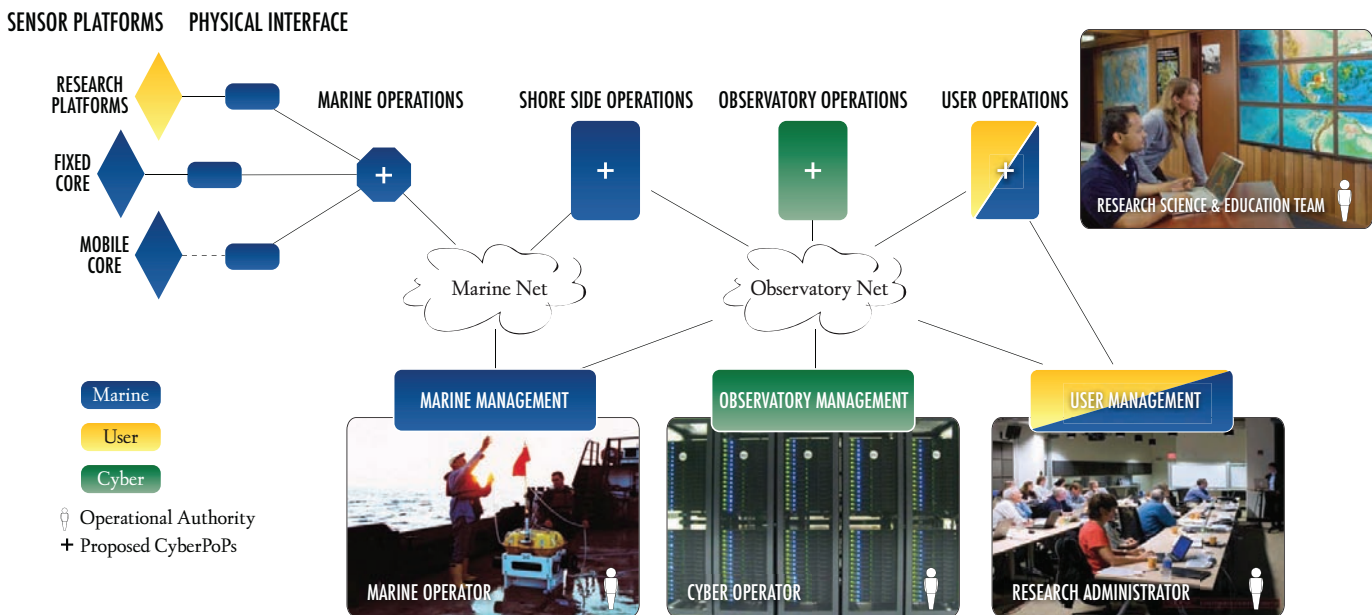

Figure 2: The ocean sensors are to the left including PI-owned instruments and users of the system are to the right. The Marine Net can be either seafloor fiber optic cables or satellite communications. The Observatory Net includes a 10Gbps fiber optic backbone from the National Lambda Rail connecting UCSD to Portland, the University of Washington, Chicago, Boston, and McLean, VA.

The Marine network provides communications at sea and a link to shoreside operations including observatory management. Users and observatory management can use the near-real-time data for real-time analysis including assimilation into models. The knowledge created from the data can, in turn, be used to modify the marine network as needed. For example, autonomous vehicles can be directed to sample data in areas in which the model variance is large in order to improve model estimates in the future. In most cases, the interactions will necessarily be machine-to-machine to reduce delays associated with human interactions.

Robert L. Parker
Professor of Geophysics, Emeritus
 Email: rlparker@ucsd.edu
 Phone: 42475

Research Interests: Inverse theory, geomagnetism, spectral analysis, electromagnetic induction.

While his student Ashley Medin continued to work on the more difficult, general inverse problem of electromagnetic induction in two dimensions, Bob Parker devoted some effort to studying the very simplest 1- and 2-D systems in order to calibrate and validate her general numerical computer codes. In magnetotelluric (MT) surveys the complex function of frequency, the admittance $c = E_y / i\omega B_x$ is measured at the Earth's surface when a horizontal time-periodic magnetic field induces currents in the ground. In the simplest case electrical conductivity in the Earth is vertically stratified, that is $\sigma = \sigma(z)$, and is terminated with a perfect conductor at the known depth h . The first question we ask is, What are the allowed values of c for such a structure, if the only other thing we know about $\sigma(z)$ is that it is positive? The surprisingly simple answer is that c must always lie within a semicircular region in the complex plane, with diameter h on the real axis and the permissible zone below it, called the *green zone*. As ω increases from zero, the admittance of any bounded one-dimensional conductivity structure traces a smooth curve inside the green zone, starting at $c = h$, and ending at $c = 0$; see Figure 1.

Next consider the following minimalist inverse problem: we measure c at exactly one frequency; what can we say with certainty about $\sigma(z)$? A common way of selecting from among the infinite number of possible conductivities is to pick the one with the smallest L_2 norm, σ with the smallest value of

$$\|\sigma\|_2 = \left(\int_0^h \sigma(z)^2 dz \right)^{1/2}. \quad (1)$$

This strategy, *regularization*, is often adopted to stabilize numerically delicate inverse problems with many data, but the most elementary problem appears to have escaped previous attention. By the classical variational method, we find the Euler-Lagrange differential equation for the complex electric field:

$$E'' = \begin{cases} i\omega\mu_0|\lambda| \operatorname{Re}(E^2 e^{i\phi}) E, & \operatorname{Re}(\lambda E^2) \geq 0 \\ 0, & \text{otherwise.} \end{cases} \quad (2)$$

where λ is a complex parameter and $\phi = \arg \lambda$. The norm minimizing conductivity is given by $\sigma = \operatorname{Re}(\lambda E^2)$ when positive, and zero otherwise. From these equations we can discover the solution to the 1-D inverse problem with the smallest L_2 norm that matches a single admittance value. The results are summarized in Figure 2 which

Figure 1: The green zone and the locus of admittances for a uniform layer.

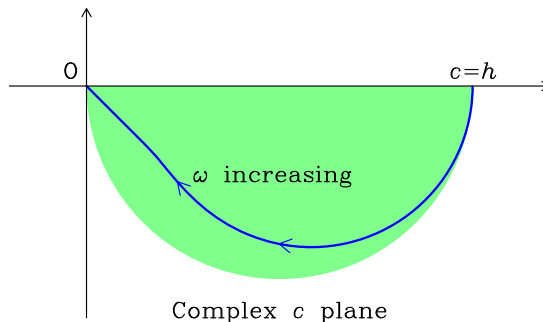

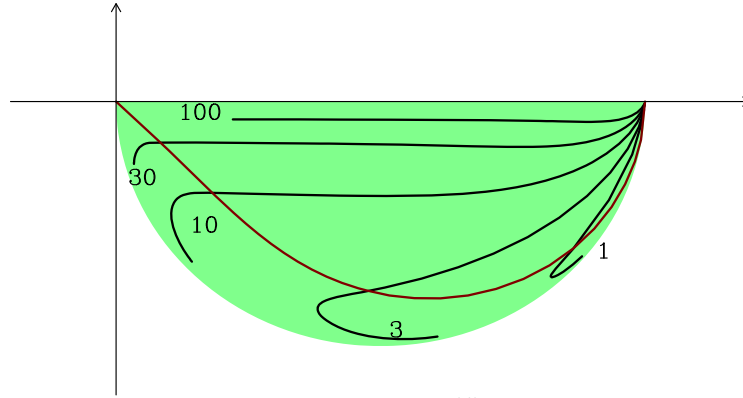

Figure 2: Contours of the smallest $\|\sigma\|_2 \omega \mu_0 h^{3/2}$ in the complex c plane. Below the red line $\sigma > 0$ throughout; above it there is an insulating layer at the top.

shows the value of the smallest possible norm at each allowed admittance. These solutions have been used as checks on the regularized 2-D numerical codes.

For quality control of MT measurements, it has been suggested that at each observation site it should be possible to construct a 1-D conductivity structure compatible with the admittances measured at that site: points lying far from the 1-D response are treated with caution and may be rejected. This is known to be only approximately correct, but the discrepancies between the best-fitting 1-D profile and a given set of data belonging to a 2-D structure have always been found to be tiny. Parker has discovered a class of 2-D systems in which the deviation can be extremely large: a thin conducting sheet with horizontally varying conductance $\tau(x)$ (vertically integrated conductivity) above an insulating layer, of thickness h lying over a perfect conductor. The system is excited by a horizontal magnetic field in the y direction in *transverse electric* (TE) mode induction. In the example illustrated below

$$\tau(x) = \tau_0(1 + a e^{-|x|/b}) \quad (3)$$

with $a = 1$ and $b = \frac{1}{2}h$; the admittances are measured at $x = 0$. If the measured admittances are to be compatible with a 1-D profile, the trajectory of $c(\omega)$ should remain inside the green zone as we discussed earlier; see Figure 1. However, for this 2-D conductivity model, the admittance lies outside the zone for every frequency except zero and infinity. Different choices of a and b yield even larger violations, but it is not known at this time if they can be made arbitrarily large. In any case, the idea that all 2-D structures have approximate 1-D responses at a single station must be reconsidered. A paper on this work is in preparation.

Figure 3: Admittances at $x = 0$ from a thin sheet conductor with conductance given by (3) and $a = 1$, $b = \frac{1}{2}h$. The dimensionless frequency $\Omega = \omega \mu_0 h \tau_0$.

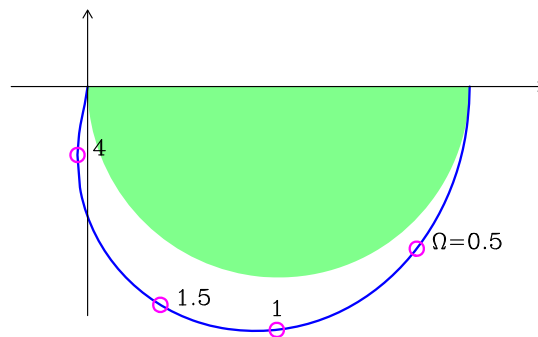

David T. Sandwell
Professor of Geophysics
Email: dsandwell@ucsd.edu
Phone: 47109

Research Interests: Geodynamics, global bathymetry, crustal motion modeling

During the 2008 academic year, Dave Sandwell's research was focused on solid Earth Geophysics with an emphasis on understanding the dynamics of the crust and lithosphere. Our group comprises three graduate students Karen Luttrell, Meng Wei, and Xiaopeng Tong as well as Post Doc. J.J. Becker. Our research is mostly supported by three grants; two are from the National Science Foundation with titles *Observations and Modeling of Shallow Fault Creep Along the San Andreas Fault Zone* and *High-Resolution Gravity, Topography, and Seafloor Roughness* while the third is from NASA to perform *Geodetic Imaging and Modeling of the San Andreas Fault System*.

Radar Interferometry - After two years in orbit, the L-Band synthetic aperture radar (SAR) aboard the Japanese ALOS spacecraft is performing beautifully and is providing global interferometric crustal motion measurements. Dave Sandwell, Xiaopeng Tong, Rob Mellors (SDSU) and Yuri Fialko, are using these data to investigate the coseismic and postseismic deformation associated with the major (M_w 7.9), and highly destructive, earthquake which occurred on May 12, 2008 in the eastern Sichuan province of China (Figure 1). We are developing new methods for mosaicking the numerous interferograms covering the 400 km by 400 km zone of deformation. This involves the development of new ScanSAR interferometry methods and code

Global Bathymetry - David Sandwell and Water Smith (NOAA - Silver Spring Maryland) continued their collaboration on retracking the raw radar altimeter waveforms from ERS-1 and Geosat to further improve the accuracy and resolution of the global marine gravity field (Sandwell and Smith, 2008). In addition they continue to advocate a new altimeter mission with a 5-fold improvement in accuracy (Sandwell et al., 2006). J.J. Becker has designed a program for editing the 40-year archive of ship soundings and has used the edited data to estimate the slope of the ocean floor in relation to the critical slope needed to convert tidal energy into internal waves (Becker and Sandwell, 2007). This research helps to resolve the issue of, where and how, deep-ocean mixing occurs.

Crustal Motion Modeling - Bridget Konter-Smith (now at the University of Texas, El Paso) continued her development of a semi-analytic model for the deformation of western North America that is consistent with the growing array of continuous GPS and InSAR measurements (Smith and Sandwell, 2006). This model was used to predict the crustal stress at seismogenic depth and at various times in the past. Karen Luttrell performed a series of GPS measurements in the Salton Trough area of California in order to measure the viscoelastic rebound of the lithosphere in response to unloading of Lake Cahuilla 300 years ago. Cyclic loading from Lake Cahuilla changes the stress field along the San Andreas Fault and could perhaps trigger a major rupture (Luttrell et al., 2007).

More information is provided at <http://topex.ucsd.edu>.

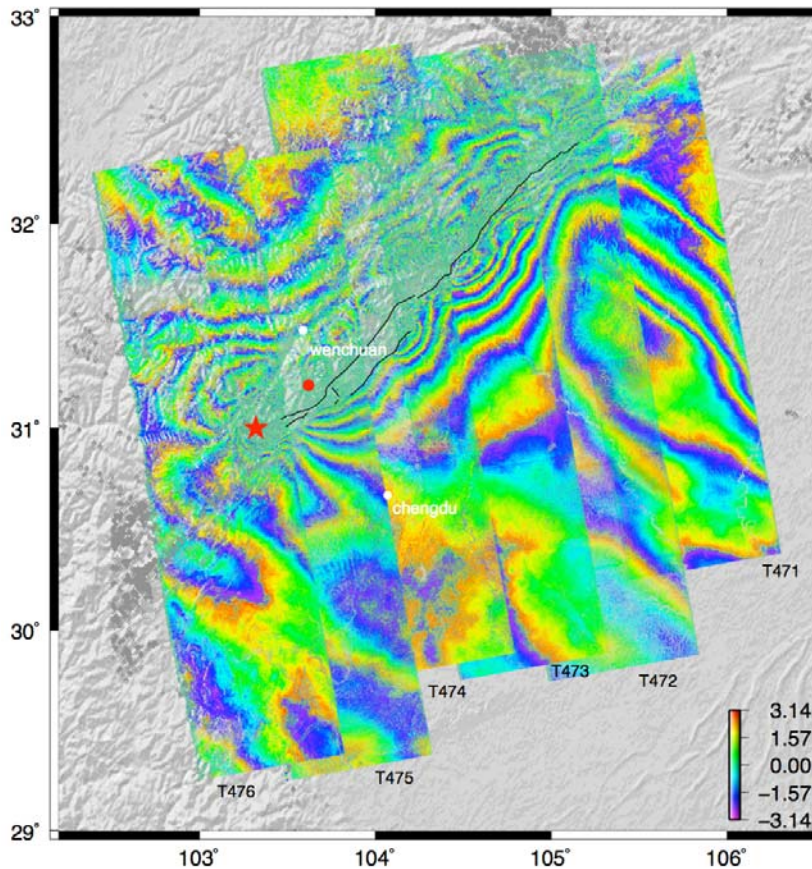

Figure 1. Six swaths of radar interferometry from the ALOS L-band spacecraft reveal the 300-km long zone of ground deformation associated with the M_w 7.9 earthquake in Sichuan Province, China that killed more than 70,000 people and left 374,000 injured. One fringe is 11.6 cm of deformation in the line of sight direction of the spacecraft. Black line is mapped surface rupture. Over the next few months we will develop viscoelastic models for the postseismic response from this major rupture in order to understand the temporal evolution of the crustal stresses.

Relevant Publications

- Becker, J. J., D. T. Sandwell, Global estimates of seafloor slope from single-beam ship soundings, *J. Geophys. Res.*, *113*, C05028, doi:10.1029/2006JC003879 30 May 2008.
- Luttrell, K., D. Sandwell, B. Smith-Konter, B. Bills, and Y. Bock, Modulation of the earthquake cycle at the southern San Andreas fault by lake loading, *J. Geophys. Res.*, *112*, B08411, doi:10.1029/2006JB004752, 2007.
- Sandwell, D. T., D. Myer, R. Mellors, M. Shimada, B. Brooks, and J. Foster, Accuracy and resolution of ALOS interferometry: Vector deformation maps of the Father's Day Intrusion at Kilauea, *IEEE Trans. Geosciences and Remote Sensing*, in press, 2008.
- Sandwell, DT; Smith, WHF; Gille, S; Kappel, E; Jayne, S; Soofi, K; Coakley, B; Geli, L., Bathymetry from space: Rationale and requirements for a new, high-resolution altimetric mission. *Comptes Rendus Geoscience*. *338* (14-15) : 1049-1062, 2006.
- Sandwell, D. T., and W. H. F. Smith, Global marine gravity from retracked Geosat and ERS-1 altimetry: Ridge segmentation versus spreading rate, *J. Geophys. Res.*, accepted, September, 2008.
- Smith, B., and D. T. Sandwell, A Model for the Earthquake Cycle Along the San Andreas Fault System for the Past 1000 Years, *J. Geophys. Res.*, *111*, B01405, 2006.
- Wei, M., D. T. Sandwell and Y. Fialko, Creep episodes on the Superstition Hills fault: A silent $M5.0$ event October 3-6, 2006, *J. Geophys. Res.*, submitted September, 2008.

Glenn Sasagawa
Associate Project Scientist

Email address: gsasagawa@ucsd.edu

Phone extension: 44329

Research Interests: Seafloor geodetic measurements.

Glenn Sasagawa's research focuses on the design, development, and deployment of scientific instrumentation to investigate geodetic questions in the marine environment. In the 2007-2008 academic year, construction of a prototype seafloor pressure reference was completed. A prototype gravimeter for deployment on an Autonomous Underwater Vehicle (AUV) was also constructed and tested at sea. Data analysis for a continuously recording seafloor instrument was completed and the results were published, along with several other papers on seafloor gravity measurements and interpretation. The geodetic research is a group effort that includes Mark Zumberge.

Seafloor Pressure Standard: Continuously recording seafloor pressure gauges have been used to monitor episodic vertical deformation on the seafloor. However, the instrument readings slowly drift in time, masking any slow signals due to seafloor deformation. We have built a laboratory prototype that can provide a stable pressure reference signal for geodetic applications. A fixed mass resting on a precisely machined hydraulic cylinder provides a known and stable pressure signal; standard pressure calibration systems use this technique. A seafloor pressure gauge would periodically measure, in situ, the reference pressure signal. In turn the pressure gauge drift would be determined and the uncontaminated slow deformation signals would be extracted.

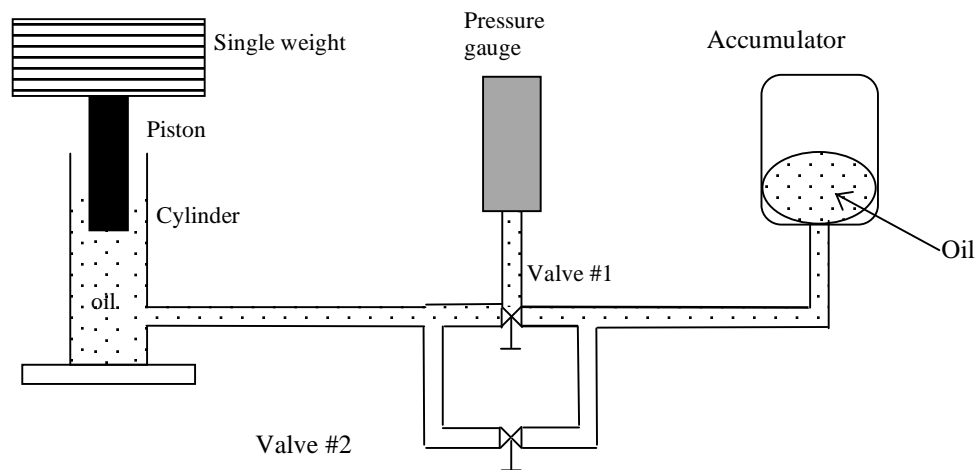

Figure 1. A schematic representation of the laboratory prototype hydraulic layout. The three-way valve #1 switches the pressure gauge between the piston gauge calibration pressure source and simulated seawater pressure simulated by accumulator (a bladder of oil inside a pressurized gas cylinder). The metering valve #2 pressurizes the piston until the weight is floated to its operating position; valve #2 is then closed.



Figure

Figure 2. The laboratory prototype. The hydraulic accumulator is the black cylinder in the background. The three-way and metering valves are labeled actuator 1 and 2, respectively. The piston gauge mass is the gray weight stack to the right; an optical pattern is attached for use with an optical tachometer. The spin-up motor assembly is mounted on the lever assembly; another motor lowers the spin-up motor onto the weights. The pressure gauge is kept in a blue insulated container in the background.

The system was operated autonomously in a temperature-controlled laboratory for 50 days. The calibrations were repeated every 2 hours initially, and then programmed to repeat every 12 hours. The nominal pressure generated by the weight is 139.305 bar. After correcting for the barometric pressure variation, the pressure repeatability as estimated by the pressure standard deviation of the values is 0.736 mbar (5.3 ppm), corresponding to seawater changes of 0.7 cm.

We are now designing a follow-on system for autonomous deployment on the seafloor. A proposed target site is Axial Volcano on the Juan de Fuca ridge, which is an active area of seafloor volcanic deformation associated with eruptive cycles.

AUV Gravimetry

Marine gravity measurements are almost always collected with gyroscopically stabilized instruments about surface ships. Surface measurements are, however, limited by physical laws to resolving seafloor features with dimensions greater than the water depth of the water. Surface measurements must also filter out the acceleration noise of the surface vessel motions.

An autonomous underwater vehicle (AUV) is essentially a robotic submarine. An AUV can carry a gravimeter much closer to the features of interest. The underwater flight of an AUV is also much smoother than that of a surface vessel. On the other hand, an AUV presents challenges in terms of relatively limited endurance, payload capacity, and navigational uncertainties. With proper design, all of these problems can be overcome.

We constructed and deployed a prototype gravimeter on board the SIO Bluefin AUV in June 2008. Initial results are encouraging, although the data analysis is still ongoing. Further testing and instrument improvements are being actively pursued.



Figure 3. AUV and gravimeter checkouts during the June 2008 test cruise

Relevant Publications

- Ballu, V., J. Ammann, O. Pot, O. de Viron, G. Sasagawa, G. Reverdin, M.N. Bouin, M. Cannat, C. Deplus, S. Deroussi, M. Maia and M. Diament. A seafloor experiment to monitor vertical deformation at Lucky Strike volcano, *Journal of Geodesy*, in press, 2008.
- Eiken, O., T. Stenvold, M. Zumberge, H. Alnes, G. Sasagawa, Gravimetric monitoring of gas production from the Troll field, *Geophysics*, in press, 2008.
- Nooner, S. L., Eiken, O., Hermanrud, C., Sasagawa, G. S., Stenvold, T., Zumberge, M. A., "Constraints on the in situ density of CO₂ within the Utsira formation from time-lapse seafloor gravity measurements." *Int. J. of Greenhouse Gas Control*, 1, 198-214. 2007.
- Sasagawa, G., M. Zumberge, O. Eiken, Long Term Seafloor Tidal Gravity and Pressure Observations in the North Sea: Testing and Validation of a Theoretical Tidal Model, *Geophysics*, in press, 2008.
- Zumberge, M., H. Alnes, O. Eiken, G. Sasagawa, T. Stenvold, Precision of seafloor gravity and pressure measurements for reservoir monitoring, *Geophysics*, in press, 2008.

Peter Shearer**Professor**

Email address: pshearer@ucsd.edu

Phone extension: 42260

Research Interests: seismology, Earth structure, earthquake physics

Peter Shearer's research uses seismology to learn about Earth structure and earthquakes, both globally and in California. His global seismology research has involved the development of new analysis approaches to handle efficiently the large digital data sets that have emerged from the global seismic networks during the last 15 years or so. In particular, he has applied stacking (averaging) methods to improve signal-to-noise ratios and make visible features in the waveforms that are not obvious on single records. This approach has proven particularly useful in studying the upper-mantle discontinuities and mapping their topography and other properties. Recent work with postdoc Jesse Lawrence (now at Stanford) mapped the transition zone thickness at higher resolution than previous studies by implementing finite-frequency sensitivity kernels (*Lawrence and Shearer, 2008*). Work with graduate student Christine Houser and Prof. Masters applied cluster analysis to long-period waveforms to produce new models of 3D velocity structure in the mantle and joint inversions for upper-mantle discontinuity topography (*Houser et al., 2008a,b*). Shearer also studies seismic scattering in the deep Earth (see *Shearer, 2007*, for a recent review), which provides sensitivity to small-scale structures that cannot be resolved with seismic tomography. Working with former student Paul Earle (USGS–Golden), he has developed stacking methods that work with high-frequency data and a Monte Carlo implementation of radiative transfer theory for modeling whole-Earth scattering.

Shearer's southern California work has focused mostly on improving earthquake locations using robust methods and waveform cross-correlation. Graduate student Guoqing Lin (now a postdoc at Wisconsin) was involved in this research and completed her thesis last year. In collaboration with Egill Hauksson at Caltech, she produced a new 3D crustal P and S velocity model for southern California (*Lin et al., 2007a*) and a catalog with precise locations for over 400,000 earthquakes from 1981 to 2005 (*Lin et al., 2007b*). These results delineate fault structures in unprecedented detail and suggest that the southernmost San Andreas Fault dips to the northeast, providing a likely explanation for the observed offset in strain across the fault. Lin also observes an interesting correlation between seismicity and low V_p/V_s ratios in her crustal tomography model. Lin and Shearer's relocated earthquake catalogs for southern California are now used by a number of researchers. For example, the relocations were used by *Plesch et al. (2007)* to help create the Community Fault Model (CFM), a database of fault geometries for southern California.

Another research topic has involved experimenting with applying backprojection (reverse time migration) to seismic records in order to directly image seismic radiation from earthquake ruptures. This method has some advantages over conventional finite-source modeling—it requires fewer assumptions about the fault geometry, it works with high-frequency data, and its computational efficiency makes it ideal for near-real-time applications. Former postdoc Miaki Ishii (now at Harvard) used backprojection to study the 2004 M9.1 and 2005 M8.7 Sumatra earthquakes (*Ishii et al., 2007*), using aftershocks as empirical travel-time correction points along these massive ruptures. Contrary to earlier reports, she found no evidence for anomalously slow slip for the northern part of the 2004 rupture. Graduate student Bettina Allmann adapted the backprojection approach to work with local strong motion data for the 2004 M6 Parkfield earthquake and solved for a fully three-dimensional image of the source (*Allmann and Shearer, 2007*). She identified a burst of high-frequency radiation that occurred about 13 km northwest of the hypocenter and 5 s after rupture initiation (see Fig. 1). This event occurred at the south end of a large area of moment release seen in long-period slip inversions and likely represents an asperity (strong patch) that, once broken, permitted greatly increased slip to the north.

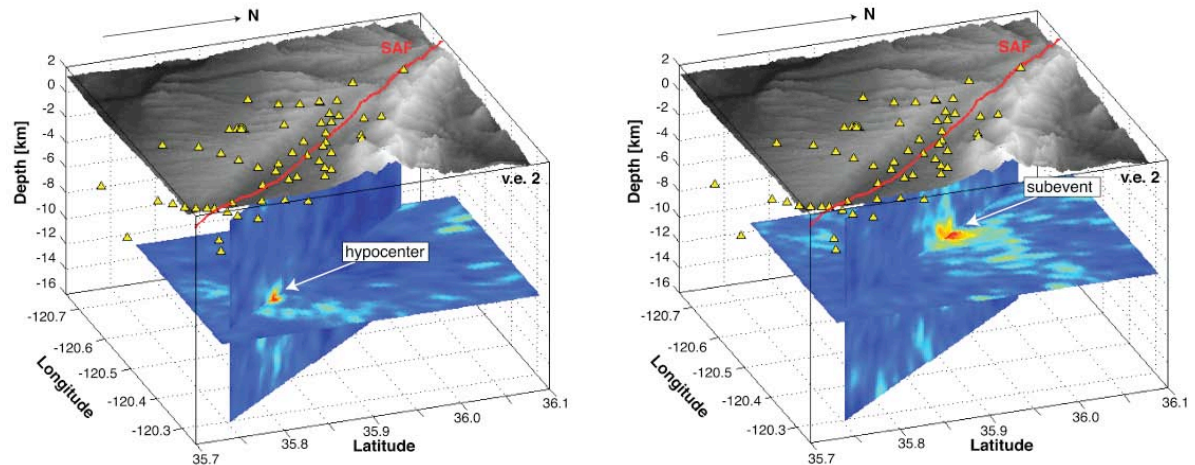

Figure 1. Images of high-frequency radiation from the 2004 Parkfield earthquake obtained using a backprojection technique applied to local strong motion records. Station locations are shown as the yellow triangles; the surface trace of the San Andreas Fault as the red line. The left panel shows energy radiating from the hypocenter at the beginning of the earthquake. The right panel shows radiation from a distinct subevent occurring 5 seconds later and 13 km northwest along the fault. From *Allmann and Shearer (2007)*.

Recent Publications

- Allmann, B. P., and P. M. Shearer, A high-frequency secondary event during the 2004 Parkfield earthquake, *Science*, **318**, 1279, doi: 10.1126/science.1146537, 2007.
- Bulow, R. C., C. L. Johnson, B. G. Bills, and P. M. Shearer, Temporal and spatial properties of some deep moonquake clusters, *J. Geophys. Res.*, **112**, doi: 10.1029/2006JE002847, 2007.
- Houser, C., G. Masters, M. Flanagan, and P. Shearer, Determination and analysis of long-wavelength transition zone structure using *SS* precursors, *Geophys. J. Int.*, **174**, 178–194, doi: 10.1111/j.1365-246X.2008.03719.x, 2008a.
- Houser, C., G. Masters, P. Shearer, and G. Laske, Shear and compressional velocity models of the mantle from cluster analysis of long-period waveforms, *Geophys. J. Int.*, **174**, 195–212, doi: 10.1111/j.1365-246X.2008.03763.x, 2008b.
- Ishii, M., P. M. Shearer, H. Houston, and J. E. Vidale, Teleseismic P wave imaging of the 26 December 2004 Sumatra-Andaman and 28 March 2005 Sumatra earthquake ruptures using the Hi-net array, *J. Geophys. Res.*, **112**, B11307, doi: 10.1029/2006JB004700, 2007.
- Lawrence, J. F., and P. M. Shearer, Imaging mantle transition zone thickness with *SdS-SS* finite-frequency sensitivity kernels, *Geophys. J. Int.*, **174**, 143–158, doi: 10.1111/j.1365-246X.2007.03673.x, 2008.
- Lin, G., P. M. Shearer, E. Hauksson and C. H. Thurber, A three-dimensional crustal seismic velocity model for southern California from a composite event method, *J. Geophys. Res.*, **112**, doi: 10.1029/2007JB004977, 2007.
- Lin, G., P. M. Shearer and E. Hauksson, Applying a three-dimensional velocity model, waveform cross correlation, and cluster analysis to locate southern California seismicity from 1981 to 2005, *J. Geophys. Res.*, **112**, B12309, doi: 10.1029/2007JB004986, 2007.
- Plesch, A., J. H. Shaw, C. Benson, W. A. Bryant, S. Carena, M. Cooke, J. Dolan, G. Fuis, E. Gath, L. Grant, E. Hauksson, T. Jordan, M. Kamerling, M. Legg, S. Lindvall, H. Magistrale, C. Nicholson, N. Niemi, M. Oskin, S. Perry, G. Planansky, T. Rockwell, P. Shearer, C. Sorlien, M. P. Suss, J. Suppe, J. Treiman, and R. Yeats, Community fault model (CFM) for southern California, *Bull. Seismol. Soc. Am.*, **97**, 1793–1802, 2007.
- Shearer, P. M., Seismic scattering in the deep Earth, in *Treatise on Geophysics, Volume 1: Deep Earth Structure*, Schubert, G. (ed.), Elsevier Ltd., Oxford, p. 695-730, 2007.

Hubert Staudigel

Research Geologist, Lecturer

Email address: hstaudigel@ucsd.edu

Personal website: <http://earthref.org/whoswho/ER/hstaudigel/index.html>

Phone extension: 48764

Research Interests: Seamounts, Volcanology, Biogeoscience, Science Cyberinfrastructure and Education

Seamounts have been a central theme in Hubert Staudigel's research since his PhD work on the seamount series of La Palma, Canary Islands (Staudigel and Schmincke, 1984). Since then he has worked on numerous aspects of seamount science, from petrology and isotope geochemistry to their Mn encrustations, macrobenthic communities and microbiology, their magnetic properties, density distribution (gravity) and seismic structure. Over the last few years most of his seamount research focused on the geochronology, geochemistry and the microbial communities colonizing them, in particular around active hydrothermal vents. Recent papers include: (1) the source region characteristics of the Samoan Islands and the discovery of the most radiogenic (extreme) EM II composition of Samoa (Jackson et al., 2007), (2) the demonstration of a systematic age progression and the "hot-spot" origin of Savaii (Samoa; Koppers et al., 2008), and (3) An isotopic investigation of previously dated seamount samples in the Western Pacific (Konter et al., in press) showed that three recently active hot spot volcanoes in the Cook-Austral island chain have been consistently producing isotopically extreme magmas suggesting an origin by long-lived hot spots.

Hubert Staudigel's involvement in volcanology includes interests in submarine volcanism and dike intrusions and he also teaches a class in volcanology whereby the next class will be in 2009 (the 2008 class was postponed due to Kilauea's eruptive activity in the main caldera). Recent volcanological studies include the discovery of potentially the oldest ophiolite on earth in the Isua Supracrustal Belt (Furnes et al., 2007) and volcano-based paleomagnetic research in Antarctica in the McMurdo volcanic series (<http://earthref.org/ERESE/projects/GOLF182/index.html>, in collaboration with Lisa Tauxe, Cathy Constable and Kristin Lawrence). The key objective of the latter is to study the fine scale (secular) variation of the magnetic field, where the HS explores field relationships and the potential for volcano-tectonic disturbance of a paleomagnetic signal.

Hubert Staudigel collaborates Brad Tebo, Alexis Templeton, Katrina Edwards, Craig Moyer and Dave Emerson and graduate students Brad Bailey and Lisa Sudeck (Haucke) to study the chemical and biological controls of water-rock interaction during seafloor alteration of the oceanic crust. Current work focuses on the characterization and isolation of microbes that facilitate these processes (Santelli et al., 2008) and the mechanisms by which microbes may dissolve in particular volcanic glass. In collaboration with H. Furnes (U. Bergen, Norway) and others Hubert Staudigel studied characteristic corrosion that is imposed by microbial activity on natural basaltic glass, and they could show that the majority of glass alteration is caused by microbial activity, in the upper 300m of the oceanic crust of all ages in the ocean basins, back through time to almost 3.5 Ba (Staudigel et al., 2008). Hubert Staudigel recently obtained funding to study microbe-rock interaction in the McMurdo extreme environments of Antarctica, where he will lead three field seasons in the 2008/9, 2009/10 and 2010/11 seasons, with co-PI Laurie Connel of U. Maine.

Hubert Staudigel is also involved in efforts creating a Cyberinfrastructure for earth science and science education, in collaboration with A. Koppers, J. Helly, C. Manduca and D. Mogk. Key

data base components include the reservoir data base for the Geochemical Earth Reference Model (GERM) initiative, the Seamount Catalog for the Seamount Biogeoscience Network (SBN) and the ERESE project (Enduring Resources for Earth Science Education), all accessible at earthref.org. Collaboration with K. Manduca of the Science Education Resource Center (SERC) at Carleton College (<http://serc.carleton.edu/sp/erese/activities.html>). Hubert Staudigel's website includes a more complete bibliography (<http://earthref.org/whoswho/ER/hstaudigel/index.html>).

Recent Publications

Banerjee N.R., A. Simonetti, H. Furnes, K. Muehlenbachs, H. Staudigel, L. Heaman and M. J. Van Kranendonk (2007). Direct dating of Archean microbial ichnofossils. *Geology*. *Geology*, June 2007; v. 35; no. 6; p. 487–490; doi: 10.1130/G23534A.1.

Furnes, H., M. de Wit, H. Staudigel, M. Rosing, K. Muehlenbachs (2007) A Vestige of Earth's Oldest Ophiolite. *Science* 23 March 2007: 1704-1707. DOI: 10.1126/science.1139170

Furnes, H., M. de Wit, H. Staudigel, M. Rosing, K. Muehlenbachs, 2007, Response to Comments on "Vestige of Earth's Oldest Ophiolite". *Science* 2 November 2007: 746E.

Jackson et al., 2007 Jackson, M. G., S. R. Hart, A.A. P. Koppers, H. Staudigel, G., J. Konter, J. Blusztjan, M. Kurz, and J.A. Russell, The return of subducted continental crust in Samoan lavas. *Nature* 448, 684-687| doi:10.1038

Konter, J.G., B. Hanan; J. Blichert-Toft; A. Koppers; T. Plank, H. Staudigel, 2008, One hundred million years of mantle geochemical history suggest the retiring of mantle plumes is premature., *Earth Planet. Sci. Lett.*, 2008 in press.

Koppers, A.A.P, Staudigel, H. J. Phipps Morgan, Robert A. Duncan, 2007, Non-linear $^{40}\text{Ar}/^{39}\text{Ar}$ Age Systematics Along the Gilbert Ridge and Tokelau Seamount Trail and the Timing of the Hawaii-Emperor Bend. *G-cubed VOL. 8, Q06L13*, doi:10.1029/2006GC001489, 2007

Koppers, AAP, J.A. Russell, M. G. Jackson, J. Konter, H. Staudigel, S. R. Hart, 2008, Samoa reinstated as a primary hotspot trail, *Geology*, v. 36; no. 6; p. 435–438; doi: 10.1130/G24630A.1; 4 figures; Data Repository item 2008102008 .

Reisberg, L., O. Rouxel, J. Ludden, H. Staudigel, C. Zimmermann, 2008, Re-Os results from ODP Site 801: Evidence for extensive Re uptake during alteration of oceanic crust. *Chemical Geology*, 248 256–271

Santelli, CM, B. N. Orcutt, Banning, E., Bach, W., Moyer, C.L., Sogin, M.L., Staudigel, H., Edwards, KJ, 2008, Abundance and diversity of microbial life in ocean crust *Nature* Vol 453|29 May 2008| doi:10.1038/nature06899

Staudigel, H., H. Furnes, N. McLoughlin, N. R. Banerjee, L. B. Connell, A. Templeton, 2008, 3.5 billion years of glass bioalteration: Volcanic rocks as a basis for microbial life? *Earth-Science Reviews* (2008), doi:10.1016/j.earscirev.2008.04.005

Frank Vernon

Research Scientist

Email address: flvernon@ucsd.edu

Phone extension: 45537

Research Interests: Time Series Analysis, Earthquake Source Physics, Seismometer Design, Real-Time Sensor Networks, Ocean Observing Systems

We operate the USArray Array Network Facility (<http://anf.ucsd.edu>), which is a key component for the NSF EarthScope MRE. This network currently has 434 seismic stations delivering real-time data to UCSD, which are redistributed to multiple sites. The ANF is responsible for real-time state-of-health monitoring for the network in addition to the real time data processing, archiving, and distribution. Data are acquired over multiple types of communication links including wireless, satellite, and wired networks. The large volumes of broad band waveform data from the transportable array element of

USArray offers a unique opportunity for seismic imaging. Constraining structures on a range of length scales and understanding their physical and chemical causes is a prerequisite for understanding the relationship between near surface and deeper mantle processes. With existing methods, we can produce 3-D models of P wavespeed variations in the mantle beneath North America using travel times from the USArray TA. This is just one example of the many scientific opportunities provided by this unique experiment.

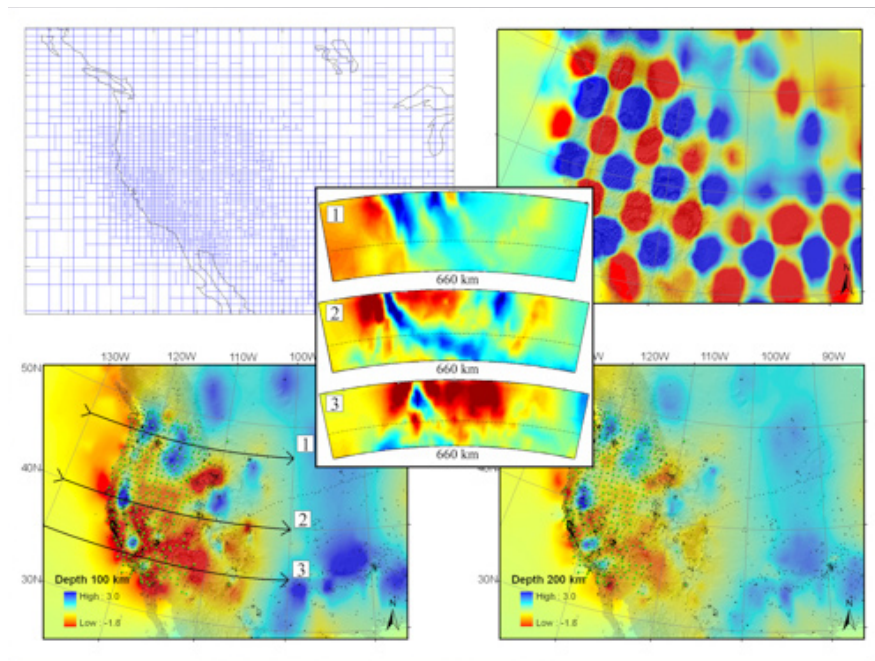
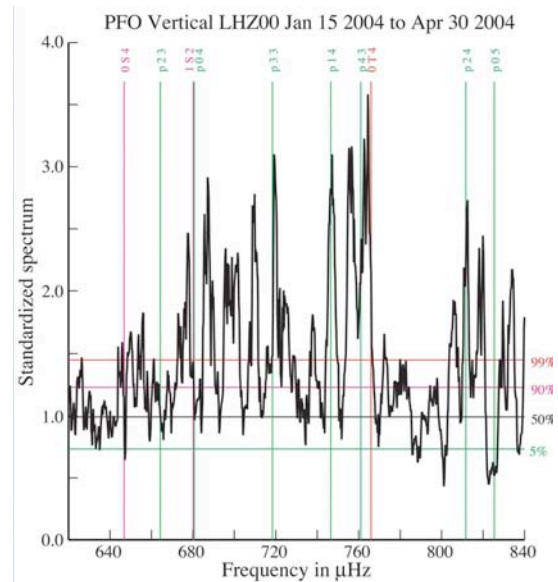

Figure 1. Results from body wave tomographic imaging using USArray. Top left the panels show grid resolution, top right checkerboard test, bottom shows map views at 100 km and 200 km depth. The middle panel shows three cross-sections.

Spectral analysis has undergone a revolution with the development of sophisticated techniques in which the data are multiplied in turn by a set of tapers that are designed to maximize resolution and minimize bias. In addition to minimizing the bias while maintaining a given resolution, the multi-taper approach allows an estimate of the statistical significance of features in the power spectrum. We are developing a quadratic inverse theory that utilizes not only the spectral estimators, but also the time and frequency derivatives of

the spectrum, to generate much higher resolution spectra. We are extending the theory from a univariate to a generalized multivariate theory. While the specific applications researched here are seismic, it is clear that there are other geophysical, scientific, and engineering applications that will benefit from the proposed studies.

Another result based on multitapers is are some unanticipated effects of the normal modes of the sun on engineering and scientific systems. Our results, based on extensive time-series studies of diverse data sources from operational communication and other engineered systems as well as the natural environment, show that much of the phenomena observed in space physics, including geomagnetic and ionospheric phenomena, exhibit a multitude of discrete frequencies over a wide frequency range superimposed on a noise background. We have hypothesized that these discrete frequencies can be explained in terms of the normal modes of the sun (solar theory, confirmed by data from helioseismology instruments that resolve spatial structure on the sun, shows that there are several million solar modes). That is, the normal modes of the sun are a dominant driver of the discrete frequencies that are measured in natural phenomena and also of the “noise” in engineered systems.



Spectral peaks in seismic data at solar mode frequencies.

A key research project is the ROADNet program (<http://roadnet.ucsd.edu>) which is focused on developing the real-time cyberinfrastructure to acquire, process, distribute, and archive data from environmental, oceanographic, geophysical, and structural monitoring sensor nets, many of which are accessed through HPWREN.

Relevant Publications

Prieto, G. A. , D. J. Thomson, F. L. Vernon, P. M. Shearer and R. L. Parker (2006). Confidence intervals of earthquake source parameters, *Geophys. J. Int.*, doi: 10.1111/j.1365-246X.2006.03257.x, Published online. Schulte-Pelkum, V., P. S. Earle, and F. L. Vernon (2004), Strong directivity of ocean-generated seismic noise, *Geochem. Geophys. Geosyst.*, 5, Q03004, doi:10.1029/2003GC000520.

G. A. Prieto, R. L. Parker, F. L. Vernon, P. M. Shearer and D. J. Thomson (2007). Uncertainties in Earthquake Source Spectrum Estimation using Empirical Green Functions. *AGU Monograph on Radiated Energy and the Physics of Earthquake Faulting* , R. E. Abercrombie, A. McGarr, H. Kanamori, and G. di Toro eds. Doi: 10.1029/170GM08 69-74.

Prieto, G. A., R. L. Parker, D. J. Thomson, F. L. Vernon and R. L. Graham (2007). Reducing the bias of multitaper spectrum estimates. *Geophys. J. Int.*, 171,1269-1281, doi: 10.1111/j.1365-246X.2007.03592.x

Thomson, D. J., L. J. Lanzerotti, F. L. Vernon, III, M. R. Lessard, and L. T. P. Smith (2007). Solar Modal Structure of the Engineering Environment. *Proc. IEEE*, 95,1085-1132, Doi: 10.1109/JPROC.2007.894712

Brad Werner

bwerner@ucsd.edu ||| <http://complex-systems.ucsd.edu>

Research interests: complexity, nonlinear dynamics and pattern formation; permafrost terrain; dynamics of human systems and human-landscape interactions; urban landscapes; dynamics of “western” and indigenous science; resistance movements; and independent media.

Brad Werner and co-workers Seth Lutske and Navjeet Sarna in the Complex Systems Laboratory have been working to develop and refine the tools used to investigate complex systems, those systems for which simple and complicated descriptions, and often a range of intermediate representations, can be constructed.

Earth's Surface in 200 Years

What will Earth's surface look like in 200 y? The vast changes that have occurred over the past 200 y and the accelerating pace of change suggest that knowledge of the current state and trends are insufficient for answering this question. Great progress has been made for physical/chemical and ecological dynamics, but large gaps exist in understanding human systems and their relationship to nonhuman natural processes.

One goal of the Complex Systems Laboratory is to help fill these gaps by developing the analysis and computational tools, within the framework of studies of complexity and nonlinear dynamics, that are necessary to make useful predictions for the future of the coupled human/Earth surface system. A second goal is to democratize knowledge of complexity analysis tools, so that a broader range of people can participate in analyzing and shaping the future of Earth's surface and the role of humans within its systems.

Human Dynamics

Discussions of human systems, ranging from the philosophizing of Deleuze to scientific studies of consciousness, commonly fail to account for the severe constraints that nonlinear/dissipative dynamics places on their possible states and outcomes. Analyses based on complexity lead to a number of insights:

Economics: That most human relations, except at the smallest scales, are now governed by profit-seeking, commodifying market dynamics permits remarkable simplification in describing the interaction of billions of people, each of whom potentially could exhibit complicated behavior. Agent-based models, in which the actions of individual or groups are represented by rule-following agents, capture the intermediate- to long-time-scale behavior of heterogeneous humans as constrained by the market system.

Political Systems and Managers: From a dynamical perspective, political systems reflect the feedbacks and power relations established within the economic system, with some notable differences. To zeroth order, political decisions are based on economic considerations, often explicitly through the use of cost-benefit analyses. These analyses and decisions made by resource and other managers tend to act as filters, introducing longer time scales and lags into decision making (having a stabilizing or destabilizing influence). The inherent nonlinearity of political processes can introduce biases and thresholds, generally favoring wealthy, organized entities over medium and longer time scales. Over short time scales, these biases are much more random, tending to make them difficult to perceive, measure or oppose.

Free Will: Much of the literature on management of Earth's subsystems and resources explicitly or implicitly assumes that individuals or people collectively can freely make decisions to influence the course of events. From a dynamical perspective, if free will decisions nontrivially exist, they manifest as extra-dynamical phenomena at fast, stream-of-consciousness time scales. They affect longer-time-scale dynamics only when they are applied at or near transitions, where the structure of phase space is flattish and a range of time scales are dynamically coupled so that these nondynamical kicks can influence the pathway and basin of attraction into which the system moves. The ability of humans to affect outcomes consciously is dependent on the dynamical context and, most likely, highly limited.

Resistance: How can those who are concerned about the pathway of the coupled global human-landscape system intentionally influence its course? Enduring course changes are unlikely to arise from deck chair rearrangements performed by those deeply embedded in the dominant global economic/political system, because of the strong feedbacks operating on them and the tenuous nature of their positions, or from

resistance movements originating from within the system, because they tend to co-evolve with and be co-opted by it (as evidenced by the dilution, distortion and neutralization of socialist and communist resistance). The pathway determined by an adaptable, powerful, global political/economic system co-evolving with internal resistance can only be diverted by groups with solid footing insulated from that system, such as indigenous cultures or those living outside the formal economic system in megacity slums.

Information Systems: Information systems ranging from corporate media to blogs, books and research articles tend to reflect economic and political relations over medium to longer time scales, with considerable variability over shorter scales, because of the ability of those with greater resources and power to steer and co-opt information streams. The dominant focus of mainstream information streams is short-time-scale phenomena, stabilizing the network of economic and power relations and resisting change, because these fast phenomena are somewhat randomized and decoupled from longer-term trends.

Human-Landscape Interactions

Humans are impacting Earth surface systems via strong effects on the atmosphere, hydrosphere, oceans and ecosystems, driven primarily by economic and political positive feedbacks involving land, mineral and ecological resources. Earth surface systems impact humans through episodic natural disasters and through regional and global trends, such as ecosystem change, soil and sediment transport, sea level rise, climate change and microbial evolution and pathogenesis. Humans and landscapes are nonlinearly coupled most strongly where fluvial, oceanic or atmospheric processes render significant stretches of human-occupied land vulnerable to large changes and damage, and where market processes assign value to the land and drive political measures to protect it from damage. These processes operate over the medium scale of many years to decades over which landscapes become vulnerable to change and over which markets drive investment in structures, evaluate profits from those investments and respond to changes in conditions.

The Complex Systems Laboratory currently is investigating human-landscape dynamics by coupling models of landscapes with agent-based models of economic development. In a model for the interaction of barrier islands with agent-based models of market-driven tourism and resort development, storm damage to resorts and coastal hazard protection measures, market dynamics destabilize barrier island response to rising sea level, giving rise to emergent, episodic boom and bust cycles that alternate in phase alongshore. At longer time scales, redistribution of sediment used to counteract erosion syncs the boom and bust cycles, leading to regional resort destruction. A model for economic development, river and hurricane-induced flooding, and levee building in New Orleans approximately reproduces historical expansion, flooding and increase in levee heights (with storm surge levees lagging river flood levees), as well as the occurrence of Katrina-scale floods-predicted to continue into the future. In-progress modeling projects include: interaction between wildfires and home development at the urban-wildland boundary; coupling between resource development, greenhouse gas emissions and climate; and widespread development of slums in megacities, largely sited in locations subject to hazards, such as landslides, floods and fires.

Democratizing Dynamics

The Complex Systems Laboratory is working to broaden access to the tools of complexity and nonlinear dynamics by: participating in community workshops and meetings; organizing complexity-related discussion groups; sharing technical and knowledge skills and equipment with community activists; meeting with on-the-ground resource managers; developing a park exhibit; and writing popular books on urban complexity and the dynamics of resistance.

--B. T. Werner & D.E. McNamara (2007) Dynamics of coupled human-landscape systems, *Geomorphology*, 91, 393-407.

--D.E. McNamara & B. T. Werner (2008) Coupled Barrier Island-Resort Model: 1. Emergent instabilities induced by strong human-landscape interactions, *JGR-Earth Surface*, 113, F01016, doi:10.1029/2007JF000840.

--D.E. McNamara & B. T. Werner (2008) Coupled Barrier Island-Resort Model: 2. Tests and Predictions along Ocean City and Assateague Island National Seashore, Maryland, *JGR-Earth Surface*, 113, F01017, doi:10.1029/2007JF000844.

--L.J. Plug & B.T. Werner (2007) Modelling of ice-wedge networks, *Permafrost & Periglacial Processes*, 19, 63-69.

--D.E. McNamara & B.T. Werner (2008) Flood evolution and human response in a coupled landscape and economic model for New Orleans, *Geophysical Research Letters*, in preparation.

Peter F. Worcester

Research Oceanographer and Senior Lecturer

Email address: pworcester@ucsd.edu

Phone extension: 44688

Research Interests: acoustical oceanography, ocean acoustic tomography, underwater acoustics

Peter Worcester's research is focused on the application of acoustic remote sensing techniques to the study of ocean temperature structure and circulation and on improving our understanding of the propagation of sound in the ocean, including the effects of scattering from small-scale oceanographic variability.

Acoustic Thermometry. Large-scale temperatures in the North Pacific Ocean were measured by long-range acoustic transmissions over the decade 1996–2006 [Worcester *et al.*, 2005]. Acoustic sources located off central California (1996–1999) and north of Kauai (1996–1999, 2002–2006) transmitted to receivers distributed throughout the northeast and north central Pacific. The acoustic travel times are inherently spatially integrating, which suppresses mesoscale variability and provides a precise measure of range- and depth-averaged temperature. The interannual, seasonal, and shorter period variability is large, with substantial changes sometimes occurring in only a few weeks. Linear trends estimated over the decade are small compared to the interannual variability and inconsistent from path to path, with some acoustic paths warming slightly and others cooling slightly. The measured travel times are compared with travel times derived from four independent estimates of the North Pacific: (i) climatology, as represented by the World Ocean Atlas 2005 (WOA05), (ii) objective

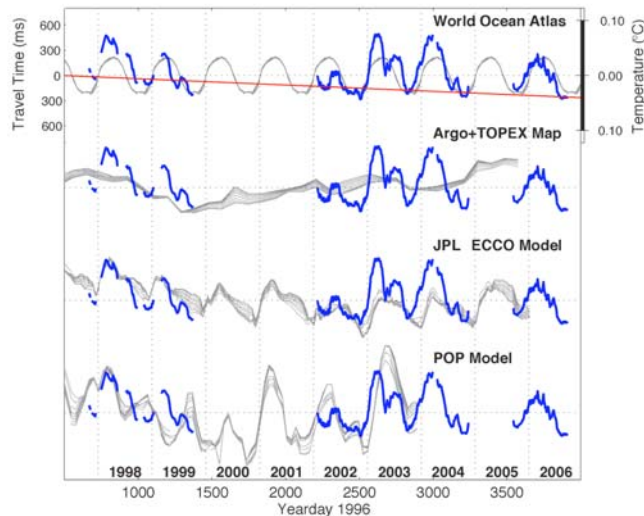

maps of the upper ocean temperature field derived from satellite altimetry and in situ profiles, (iii) an analysis provided by the Estimating the Circulation and Climate of the Ocean project as implemented at the Jet Propulsion Laboratory (JPL-ECCO), and (iv) simulation results from a high-resolution configuration of the Parallel Ocean Program (POP) model. The comparisons provide a stringent test of the large-scale temperature variability in the models. The differences are sometimes substantial, indicating that acoustic thermometry data can provide significant additional constraints for numerical ocean models.

Figure 1. Comparison of measured travel times for transmissions from the Kauai source to receiver k at a range of approximately 3500 km (blue) with travel times calculated using sound-speed fields derived from the World Ocean Atlas 2005, objective maps combining in situ temperature profiles and sea surface height from satellite altimetry (Argo+TOPEX Map), the JPL-ECCO model, and the POP model (gray). For comparison, the trend in travel time corresponding to a 5 m°C/year change in temperature at the sound-channel axis is also shown (red).

North Pacific Acoustic Laboratory (NPAL). Over the last twenty years, long-range, deep-water acoustic experiments have been performed almost entirely in the relatively benign northeast and north central Pacific Ocean [Worcester and Spindel, 2005]. The NPAL Group is now preparing to conduct a yearlong experiment in the much more variable northern Philippine Sea in 2010–2011, preceded by a short-term Pilot Study/Engineering Test in April-May 2009. The experiment in 2010–2011 will combine measurements of acoustic propagation and ambient noise with the use of an ocean acoustic tomography array to help characterize this highly dynamic region. The tomographic measurements, when combined with satellite and other in situ measurements and with ocean models, will provide an eddy-resolving, 4-D sound-speed field for use in making acoustic predictions. The receivers include a new Distributed Vertical Line Array (DVLA) receiver that spans the water column.

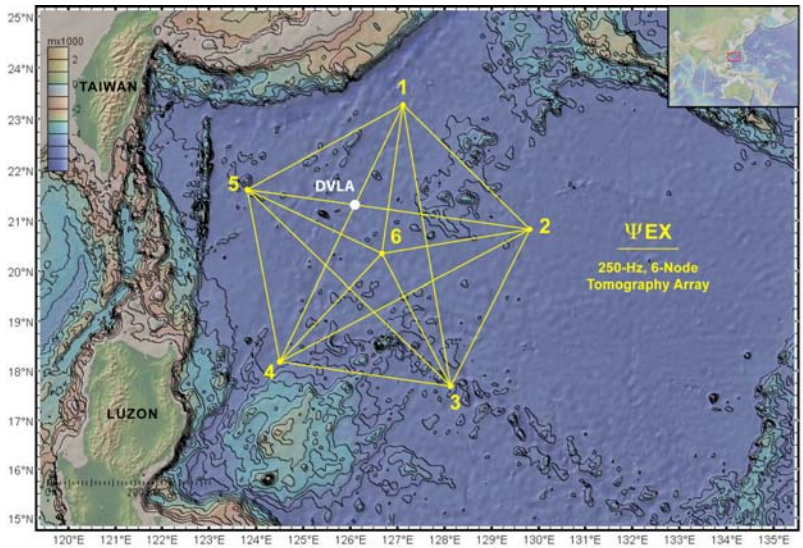

Figure 2. Overall mooring geometry of the 2010–2011 Philippine Sea Experiment, consisting of six 250-Hz acoustic transceivers (T1, T2, ... T6) and a new DVLA receiver. The array radius is 330 km.

The goals are to (i) understand the impacts of fronts, eddies, and internal tides on acoustic propagation in this complex region, (ii) determine whether acoustic methods, together with satellite, glider and other measurements and coupled with ocean modeling, can yield estimates of the time-evolving ocean state useful for making improved acoustic predictions and for understanding the local ocean dynamics, (iii) improve our understanding of the basic physics of scattering by small-scale oceanographic variability due to internal waves and density-compensated small-scale variability (spice), and (iv) characterize the ambient noise field, particularly its variation over the year and its depth dependence. The ultimate goal is to determine the fundamental limits to signal processing in deep water imposed by ocean processes, enabling advanced signal processing techniques to capitalize on the three-dimensional character of the sound and noise fields.

Relevant Publications

Worcester, P. F., Munk, W. H., and Spindel, R. C., Acoustic remote sensing of ocean gyres, *Acoustics Today*, 1, 11–17, 2005.

Worcester, P. F., and Spindel, R. C., North Pacific Acoustic Laboratory, *J. Acoust. Soc. Am.*, 117, 1499–1510, 2005.

Mark A. Zumberge

Research Geophysicist

Email address: zumberge@ucsd.edu

Phone extension: 43533

Research Interests: Measurement of gravity in the marine and subaerial environments, development of new seismic instrumentation, optical fiber measurements of strain and pressure

A borehole strainmeter using optical fibers

The measurement of Earth strain provides insight into a wide variety of geophysical processes, including tectonic deformation associated with earthquakes, volcanoes, ocean ridge spreading, and sea floor subduction. Strain measurements can also be used to monitor the flow of glacial ice (a problem to which optical fibers have proven to be particularly well suited), and they are applicable in geotechnical arenas such as hydrocarbon reservoir monitoring and the observation of sediment movements on the sea floor.

In strain measurements there is an advantage for the length of the sensor to be large. Because strain is defined as $\Delta L/L$, strain noise is smaller for a given displacement (ΔL) noise if the instrument length L is long. In geophysical applications, noise in ΔL often results from imperfect coupling to the ground. Increasing the sensor length lessens this impact. Optical fibers have the advantage that optical methods can be applied to detect a very small ΔL even when L is large. They are therefore useful for strain measurements. The main drawback to optical fibers as strain sensors is the temperature coefficient of the index of refraction (about $10^{-5} \text{ }^\circ\text{C}^{-1}$).

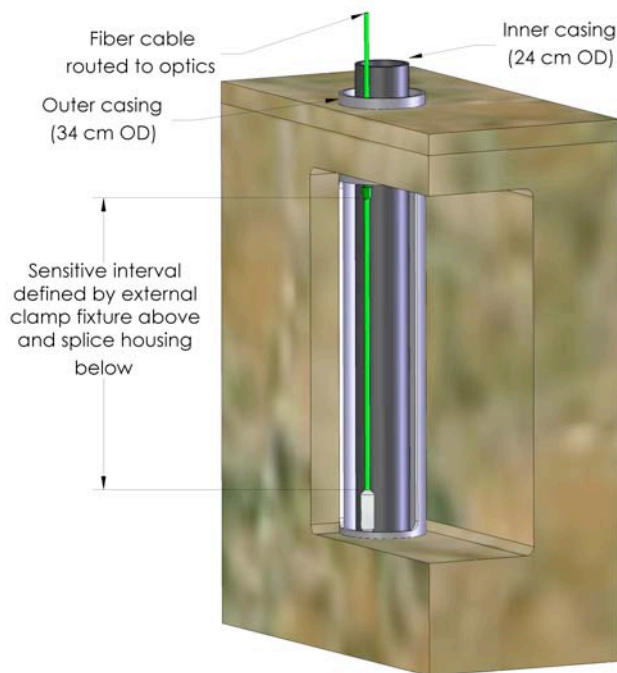
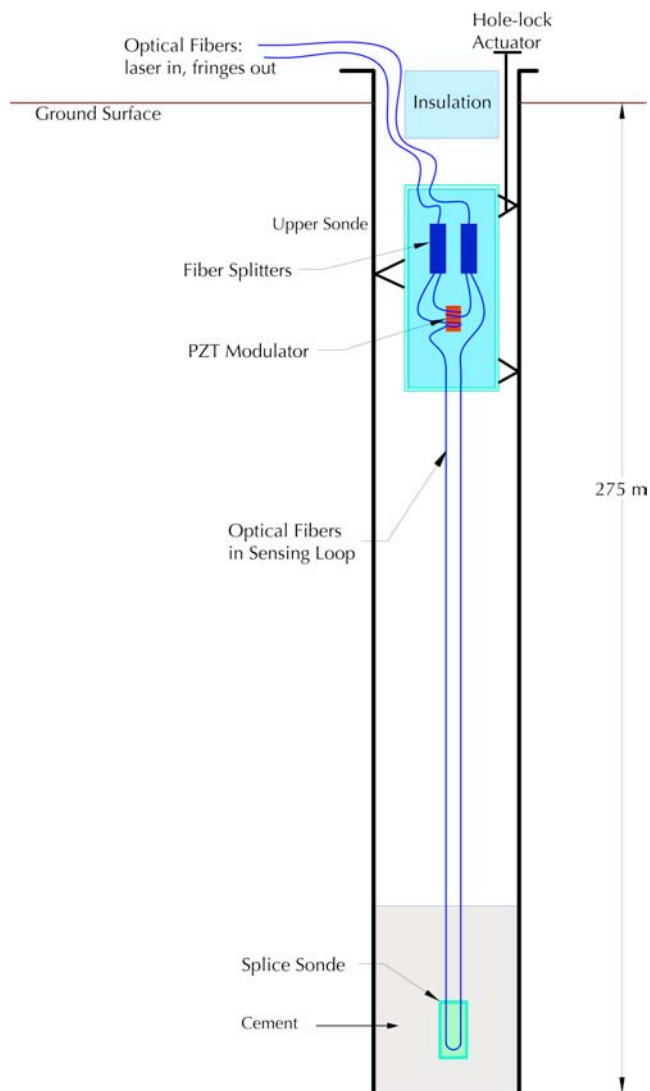

Figure 1: This is a cut-away view of an optical fiber strainmeter deployed at the SAFOD (San Andreas Fault Observatory at Depth) borehole near Parkfield, California. First an outer casing was installed as the borehole was drilled to several km depth and then angled to pierce the San Andreas Fault. Later an inner casing was inserted, which extends to greater depths. We took this opportunity to install an experimental borehole strainmeter. Within the green cable shown at left, two optical fibers are stretched to 800 m depth and cemented into the space between the inner and outer casings, where they won't interfere with other activity in the borehole.

Laser light is sent down one optical fiber and back up the other. At the surface the light interferes with a reference beam. As Earth strains and changes the length of the stretched optical fibers, the phase of the light that passes through them changes causing a fluctuation in light intensity recorded by a photodetector. These variations in light level are analyzed with a digital signal processor to yield a recording of the total length with nanometer resolution.



An important target of this type of measurement is the seafloor, where conventional instrumentation is difficult or impossible to operate. It is hoped that optical fiber sensing techniques like this one will enable strain measurements to be made near seafloor tectonic features.

Figure 2. We have received funding to build a second optical fiber borehole strainmeter at our high desert station: Piñon Flat Observatory. One problem with our SAFOD sensor is from thermal noise caused by air temperature variations above the ground, where the sensing fiber is exposed. In our new instrument, all of the sensitive parts of the instrument will be within the borehole, where the temperature is quite stable.

Relevant Publications

Blum, J. A., Nooner, S. L., Zumberge, M. A., "Recording Earth strain with optical fibers." *IEEE Sensors Journal*, **8** (2008): 1152 – 1160.

Zumberge, M. A., "Geophysical applications of optical fiber sensors." In: *Fiber optic sensors and applications V*, Eric Udd ed., *Proc. SPIE*, 6770, (2007);0, 67700Q-1, 67700Q-9.



Cecil H. and Ida M. Green Institute of Geophysics and Planetary Physics, SIO/UCSD
9500 Gilman Drive, La Jolla, CA 92093-0225, USA; Ph: +1.858.534.1927

www.igpp.ucsd.edu

